

Laser Autocollimator

Smart LAC

H410 Series

User's Manual

Thank you very much for purchasing this product.
Read this manual carefully before using the product.
After done reading this manual, store in a safe place for
easy reference.



Safety Cautions

Introduction

This document is a “User’s Manual” of Model H410 laser autocollimator (hereinafter, referred to as “this product”).

In this “User’s Manual”, information and basic operation methods on this product are described. Read this document carefully to use this product effectively and safety, and sufficiently understand its contents.

Symbols and Meaning

In this document, items to be followed to avoid injuries of the operators who use this product and other people, and damage to physical properties are indicated with the following symbols.

Danger

If not followed, it indicates that “It is highly possible to cause death or serious injuries”.

Warning

If not followed, it indicates that “It is possible to cause death or serious injuries”.

Caution

If not followed, it indicates that “It is possible to cause light injuries or only physical property damages”.

NOTE

It describes items to pay attention when operating and handling this product.

Info

It describes reference items useful when operating and handling this product.

Handling of this Product

- Before starting or operating this product, please check the functions and performance of this product are operating correctly.
- If this product is not working properly, take sufficient safety measures to prevent various damages, and contact our sales office.
- When this product is used out of standards indicated in the specifications or in a modified state, be cautious that we cannot cover the functions and performance under the warranty.
- When this product is used by combining with other devices, please consider carefully, because its functions and performance may not be satisfied due to the use condition and environment.
- Do not use this product to protect human bodies and a part of human bodies.
- This product is not designed to be used in areas where explosion proof is necessary. Do not use this product in areas where explosion proof is necessary.
- Including external devices, do not apply rapid temperature changes to each device. Condensation may cause the device to fail.
- IPU (Image Processing Unit) to connect to this product should be placed vertically. Do not place is horizontally.
- Do not wipe this product with wet cloth, benzine, and thinner. It may cause discolorization and deformation of this product. When heavy soil is present, soak a cloth to a diluted neutral detergent, wipe it by squeezing off the detergent well, and wipe it dry with a soft cloth.

Caution on Installation Environment

Caution

Do not install this product in the following places in order to use this product normally or safely.

- Highly humid place, dusty place, and place with bad ventilation.
- Places where temperature gets high such as by direct sunlight.
- Near flammable locations.
- Places where there are corrosive gases and inflammable gases.
- Places where vibration and shock are directly applied.
- Places where splash from water, oil, and drugs gets on this product.
- Places where static electricity is likely to be generated.
- Tilted and unstable places.

■ Measures Against Electrical Noise

Caution

When installing this product near electrical noise sources such as a power source and high-voltage lines, the electrical noise may cause malfunction and damage. Take measures such as use of electrical noise filters, a separate piping of various cords, and attaching an insulation to the controller and measurement parts.

Safety Cautions

■ Ambient Temperature

⚠ Caution

Changes of ambient temperature may cause measurement errors. Keep it constant. The use environment temperature of this product is 0 to 40°C, and the performance guarantee temperature is 23°C ± 5°C.

■ Ambient Lighting

⚠ Caution

Do not use this product near a lighting facility where ON/OFF in a high frequency is repeated. When it cannot be avoided, install a shielding plate to minimize its effect.

Caution When Using

⚠ Warning

- Use with a correct power source voltage. It may cause fire, electric shock, and damage.
- Do not disassemble/modify the unit. It may cause fire and electric shock.

⚠ Caution

- Be sure to turn off the power of the product and the devices connected to the product when connecting or disconnecting the cord. It may cause damage.
- Do not turn the power source OFF while setting the items. A part or all of setting data may be lost.
- Do not block the ventilation hole of the main body. Inside temperature increases and it may result in damage.

■ Dirt and Dust

⚠ Caution

In the following cases, measurement errors may be generated due to the effect of dirt, dust, or water and oil.

- Adhesion of the dust to the cover glass: Blow a clean air to remove the dirt on the cover glass. If it is extremely dirty, wipe off with a soft cloth soaked in alcohol.
- Adhesion to a measurement target surface: Blow with a clean air, and wipe off the dirt.
- Penetration from floating to the optical axis region and by splash: Take measures by installing a protection cover and air purge.

■ Measured Target

When the shape of measured target and surface state are different, measurement errors may be generated. In the case, use a known target object, and correct with the angle correction function.

■ Vibration

If a measurement target object is vibrating, the measured values may vary. In the case, a more precise measurement is possible by increasing the number of measurement values to calculate an average.

■ Air Fluctuation

A slow air fluctuation may cause measured values to vary. In such a case, the following measure is effective.

- Cover the measurement part with a wind-proof cover.

Measures for Errors

Warning

In the next case, promptly turn the power source OFF. If this product is kept using in an abnormal state, it may cause damage.

Please contact our sales agency for repair.

- When water and foreign objects enter inside.
- This product is dropped and the case is damaged.
- Smoke comes from the controller and it smells strange.

CE Marking

This product comply with CE marking for the following complying standards and conditions. When this product is used in EU countries, keep the following conditions.

- EMI: EN61326-1 Class-A
- EMS: EN61326-1

* All cable lengths for input and output containing the power source cable to connect IPU are less than 30 m.

Safety Cautions

Safe Use of Laser Product

This product is laser class 1 product.

Use this product paying attention to the following items.

- Do not look laser light directly for a long time.
- Do not disassemble this product.

Caution

Use of controls or adjustments or performance of procedures other than those specified here in may result in hazardous radiation exposure.

■ Warning Label

Display contents of this product's warning labels and their pasting positions are shown next.

● Display contents of laser label.

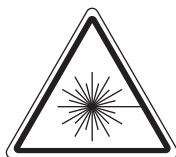

About KC correspondence : Class A

사용자 안내문

이 기기는 업무용 환경에서 사용할 목적으로 적합성평가를 받은 기기로서 가정용 환경에서 사용하는 경우 전파간섭의 우려가 있습니다.

Reference English translation:

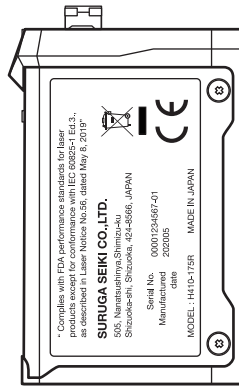
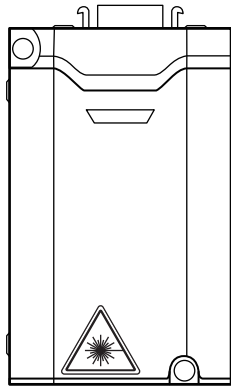
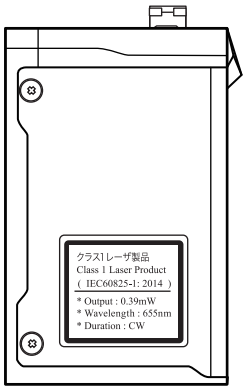

User guide This equipment has been conformity-assessed for use in a professional environment and Interference may occur.

● Laser label location.



Contents

Safety Cautions	i
Introduction	i
Handling of this Product	ii
Caution on Installation Environment	ii
■Measures Against Electrical Noise	ii
■Ambient Temperature	iii
■Ambient Lighting.....	iii
Caution When Using	iii
■Dirt and Dust.....	iii
■Measured Target.....	iii
■Vibration.....	iv
■Air Fluctuation.....	iv
Measures for Errors	iv
CE Marking	iv
Safe Use of Laser Product	v
■Warning Label.....	v
0 Introduction	0-1
What are Laser Autocollimators?	0-2
■Measuring Angles	0-2
■Comparing 2 or more Target Objects.....	0-3
■Measuring in R, G, B, and Infrared Wave Lengths	0-4
■Single Spot and Multi-spot Measurement.....	0-4
■H410 Series Models	0-4
1 Preparations	1-1
System Configurations	1-2
Each Part's Name and Function	1-3
■IPU.....	1-3
■Sensor Head.....	1-4
IPU Installation	1-5
Installation of Each Part	1-5
■Installation of the sensor head.....	1-5
■Mount the sensor head to the stand (HA-14)	1-6
■Installation of Touch Panel Monitor.....	1-7
■Installation of External Devices	1-8
Applying Power Source	1-8
Function Overview	1-9
■List of Functions	1-9
Flow of Measurement	1-11

2	Setting	2-1
	Setting Method	2-2
	■Basic Flow of Setting	2-2
	■[Settings] Screen Details	2-4
	■List of Settings Menu	2-5
	■Numerical Value Input Method.....	2-6
	Use of Setting File	2-7
	■Loading of Setting File	2-7
	■Copying Setting File	2-9
	■Resetting Setting File	2-10
	■Name Change of Setting File	2-11
	 Setting of Basic Conditions	2-13
	 Setting of Detail Conditions	2-14
	■Setting of Measurement Conditions [Measurement]	2-15
	■Settings of Camera [Camera]	2-25
	■Settings of Display State [Display].....	2-26
	 System Settings	2-28
	■Settings of System Configuration [Configuration]	2-28
	■Settings of Angle Calibration [Calibration]	2-30
	■Verification of System Information [Information]	2-30
3	Measuring	3-1
	Overview of Measurement Screen	3-2
	Settings of the Measurement Mode	3-4
	Settings of the Judgment Area	3-6
	Verification of Measurement and Judgment Results	3-10
	■Single Measurement Mode.....	3-10
	■Multi Relative Measurement Mode	3-11
	■Multi Absolute Measurement Mode	3-12
	■Offset Tilt Measurement Mode.....	3-13
4	Angle Calibration	4-1
	Overview of Angle Calibration	4-2
	■Wedge Substrate and Wedge Mirror that can be Used (made by Suruga Seiki)	4-2
	Angle Calibration	4-3

Contents

5	Control from External Devices	5-1
	Connection Specifications with External Devices	5-2
	■ Connection with RS232C	5-2
	■ Connection with Ethernet	5-3
	Setting the PC Network and IPU (Image Processing Unit) IP Address	5-4
	■ Setting the PC Network IP Address	5-4
	■ H410 Model System Setting	5-7
	Setting the FTP	5-9
	■ Enabling the FTP Server Function.....	5-9
	■ Creating a User	5-10
	■ Setting the FTP Server	5-12
	■ Permitting Communication Through the Firewall.....	5-16
	■ Starting the FTP Server	5-18
	■ Setting an IP Address Connecting to the FTP Server.....	5-20
	■ Setting the IPU FTP.....	5-20
	■ Supplementary Items.....	5-21
	Operating the Setup Transfer Tool	5-22
	■ Starting the Setup Transfer Tool	5-22
	■ Understanding the [Setup Transfer Tool] Window	5-23
	■ Adding Devices.....	5-24
	■ Removing Devices.....	5-25
	■ Connecting Devices.....	5-26
	■ Downloading Setting Files	5-27
	■ Uploading Setting Files.....	5-27
	■ Updating Firmware	5-28
	Data Communication Format	5-30
	■ Measurement Results Output Formats.....	5-30
	Device Control with External Commands	5-31
	■ List of External Commands	5-31
	■ Command Format.....	5-33
	■ Communication Error.....	5-50
6	Using Input/Output Terminal	6-1
	Name of Input/Output Terminal and Function	6-2
	■ Equivalent Circuit Scheme	6-3
	Timing Chart	6-6
	■ Internal Trigger Mode	6-6
	■ External Trigger Mode	6-7
	■ Details of Strobe Signal	6-8
	■ Details of Zero Set Signal.....	6-8

7	Specification	7-1
	Main Specifications	7-2
	■ IPU	7-2
	■ Sensor Head	7-3
	■ AC Adaptor (Optional)	7-4
	■ Sensor Head Cable	7-4
	■ Robot Cable	7-4
	External Dimensions	7-5
	■ IPU HPU-500, HPU-1000	7-5
	■ Sensor Head H410 Series	7-6
8	Troubleshooting	8-1
	LED display state	8-2
	Error messages	8-2
	Phenomena and measures	8-3
	Warranty	Back Cover

0

Introduction

What are Laser Autocollimators?0-2

What are Laser Autocollimators?

Laser autocollimators are measuring instruments which use laser light for non-contact measurement in real time of minuscule angles on the target object or minuscule angle relations on multiple target objects. Below are examples of the use of laser autocollimators.

■ Measuring Angles

Laser autocollimators measure minuscule angles of the target object or of the customer's laser light. An internal light source is used when measuring the target object; the angle of its reflected light is measured.

With an external light source, the laser or LED luminous flux is directly measured to calculate the angle.

- For internal light source

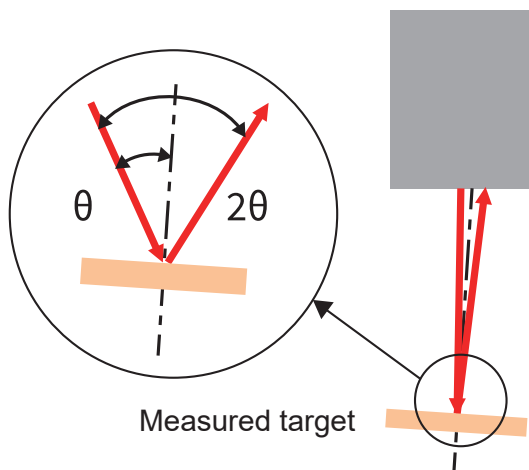

- For external light source

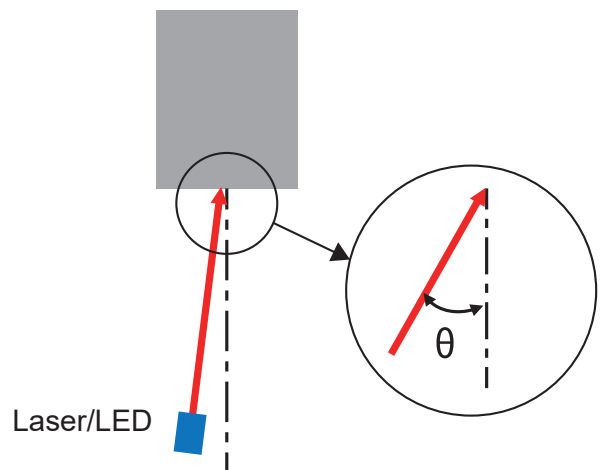

With an internal light source, the angle of 2θ is measured and the value of θ shown through calculation.

With an external light source, the value of θ is shown as is.

With an external light source, when different from the laser autocollimator's specified wave length, errors are generated due to chromatic aberration, rendering precision impossible to guarantee.

Be careful with the equipment's external and internal light source settings.

■ Comparing 2 or more Target Objects

By using a dedicated adapter, the difference in minuscule angles on two or more target objects or their parallelism can be easily measured.

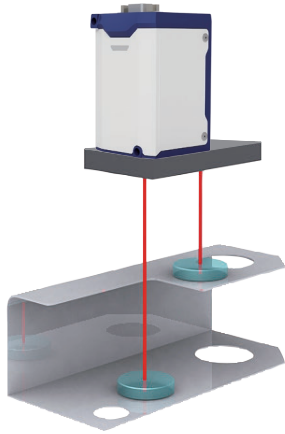

Example 1: Height difference

The laser autocollimator can measure the target object's angles regardless of differences in working distance. By using a beam split adapter, the minuscule angles (parallelism) of parts with different heights can be measured.

Usable for machining accuracy judgments of precision press parts, etc.

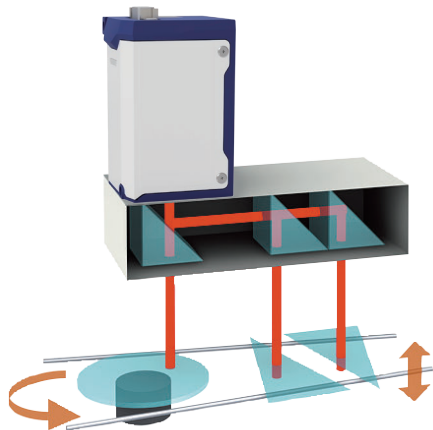

Example 2: Multi-beam split

Angles can be measured simultaneously on two or three different target objects. Usable for adjustment of assembly and light paths on precision motors.

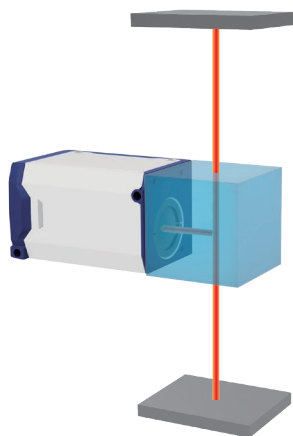

Example 3: Parallelism adjustment

The parallelism of two facing target objects can be measured.

Usable for adjustment in parallelism measurement, such as adjustment of precision presses or devices on an optical surface plate.

0 Introduction

■ Measuring in R, G, B, and Infrared Wave Lengths

Wave length
R: 655 nm
G: 520 nm
B: 450 nm
Infrared: 852 nm

The laser autocollimator offers four internal light source types.

Select the wave length in accordance with the reflectance wave length properties of the target object or the wave length used by the optical device at hand.

Use with an external light source is also possible, but when the internal and external light sources use different wave lengths, errors are generated due to chromatic aberration, rendering precision impossible to guarantee.

■ Single Spot and Multi-spot Measurement

Two types of image processing units are available: single spot measurement, which measures the angles of one luminous point at once, and multi-spot measurement, which measures up to five luminous points at once.

Image processing unit	Function
HPU-500	Measurement of one luminous point from up to five luminous points
HPU-1000	Simultaneous measurement of up to five luminous points as well as measurement of the relative angles between them

■ H410 Series Models

Characteristics: (1) Select from four wave length types

(2) Select from single spot and multi-spot measurement

(3) Sensor head compatibility

With calibration data inside the sensor head, connection of multiple sensor heads to one image processing unit is possible without adjustment

Wave length	Sensor head	Image processing unit
655 nm	H410-175R	HPU-500
520 nm	H410-175G1, H410-175G1-30	HPU-1000
450 nm	H410-175B1	
852 nm	H410-175S1	

Select a model in accordance with the wave length and type of measurement (single spot/multi-spot) used.

Note that HPU-500 is sold as a set with the sensor head.

1

Preparations

Preparations such as system configurations and function overview of this product that are necessary before using this product are explained.

System Configurations	1-2
Each Part's Name and Function.....	1-3
IPU Installation.....	1-5
Installation of Each Part.....	1-5
Applying Power Source	1-8
Function Overview	1-9
Flow of Measurement.....	1-11

1 Preparations

System Configurations

This product can be used for measurement alone or in combination with commercially available equipment.

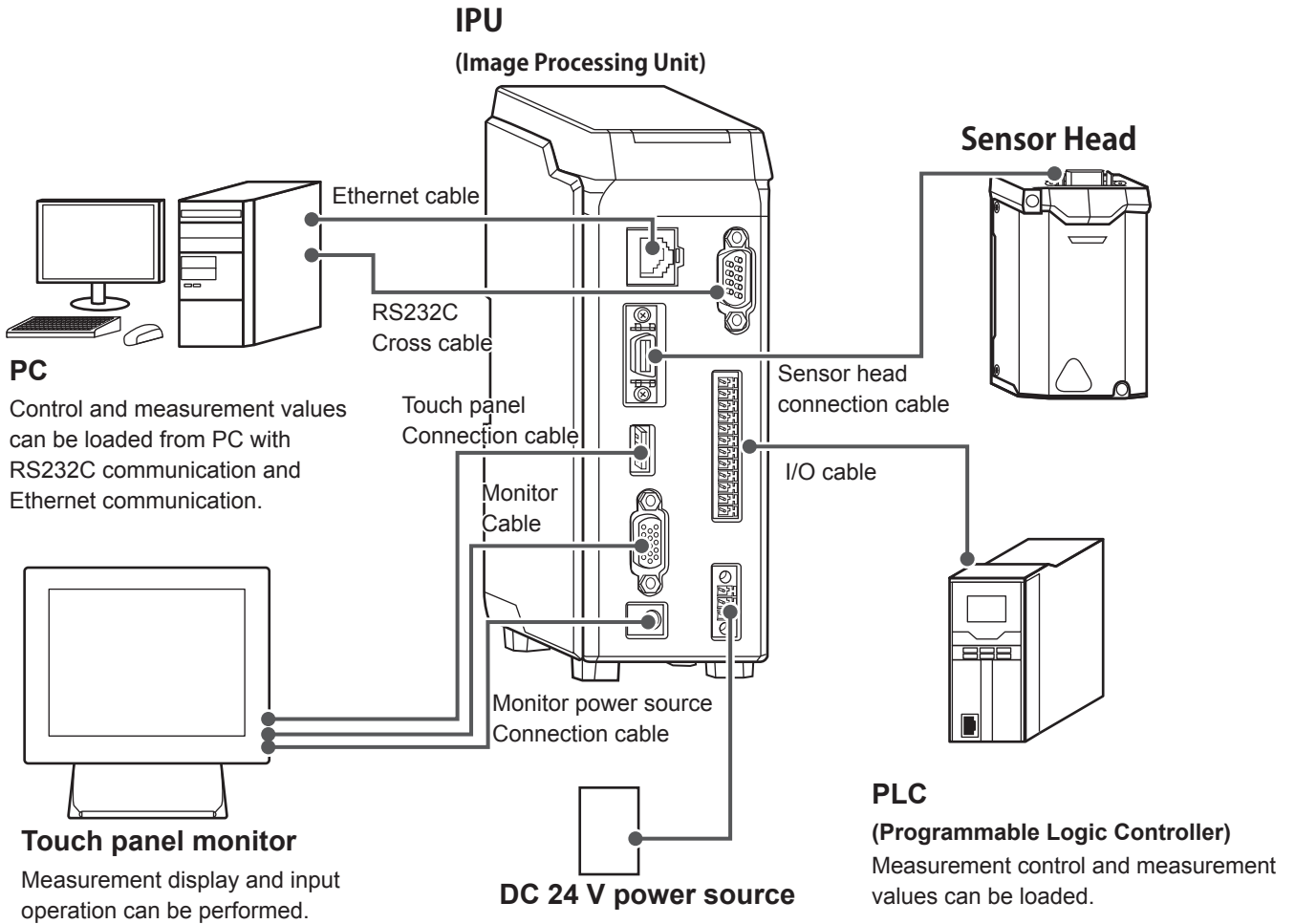

Each Part's Name and Function

Each part's name and function are described.

■ IPU

① State display lamp

Turns on in green when the power is ON.
Turns on in red when there are problems like errors.

② Ethernet connector

Connects to external devices like PC. (→Page 5-1)

③ Head connector

Connects with the sensor head (1). (→Page 1-5)

④ USB connector

Connects the touch panel connection cable (USB cable).
(→Page 1-7)

⑤ Monitor connector

Connects the monitor cable (VGA cable D-sub 15-pin).
(→Page 1-7)

⑥ Monitor power source connector

Connects the monitor power source cable. (→Page 1-7)

⑦ RS232C connector

Connects to external devices like PC. (→Page 5-1)

⑧ 12-core connector

Connects to a device that operates input/output signals such as PLC. (→Page 6-2)

⑨ DC 24 V power source connector

Connects to the DC 24 V power source. (→Page 1-8)

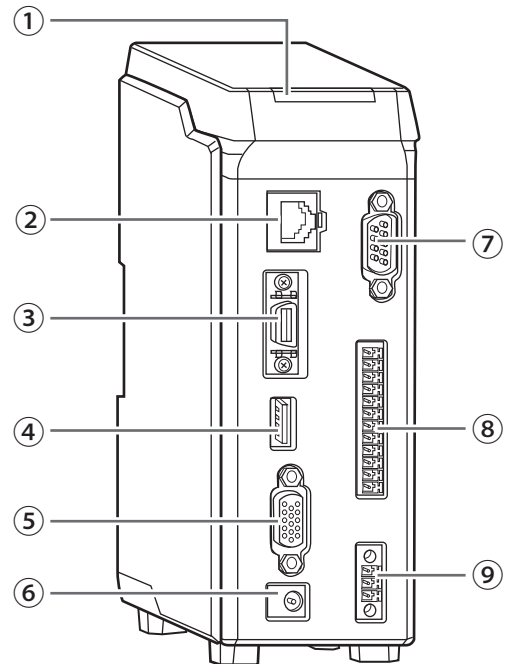

1 Preparations

■ Sensor Head

① **IPU connection connector**

Connects to IPU.

② **State display lamp**

Turns on in green when the power is ON.
Turns on in red when there are problems like errors.

③ **Laser emission port**

Emits laser.

⚠ Warning

Do not point the laser emission port to eyes.

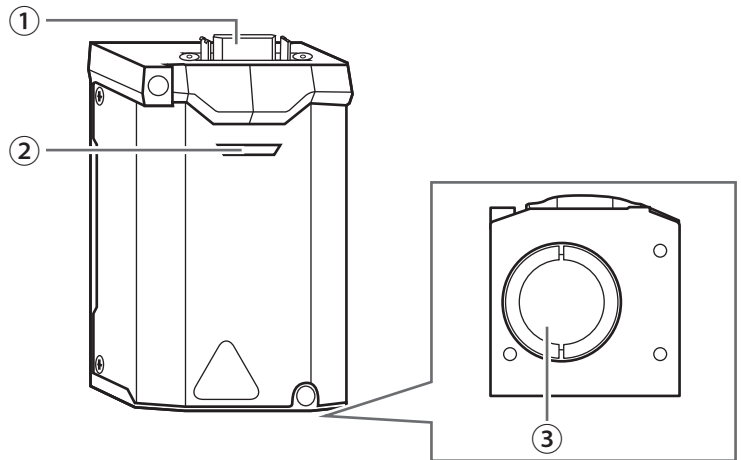

IPU Installation

IPU should be installed in the following environment.

NOTE

Do not place it horizontally.

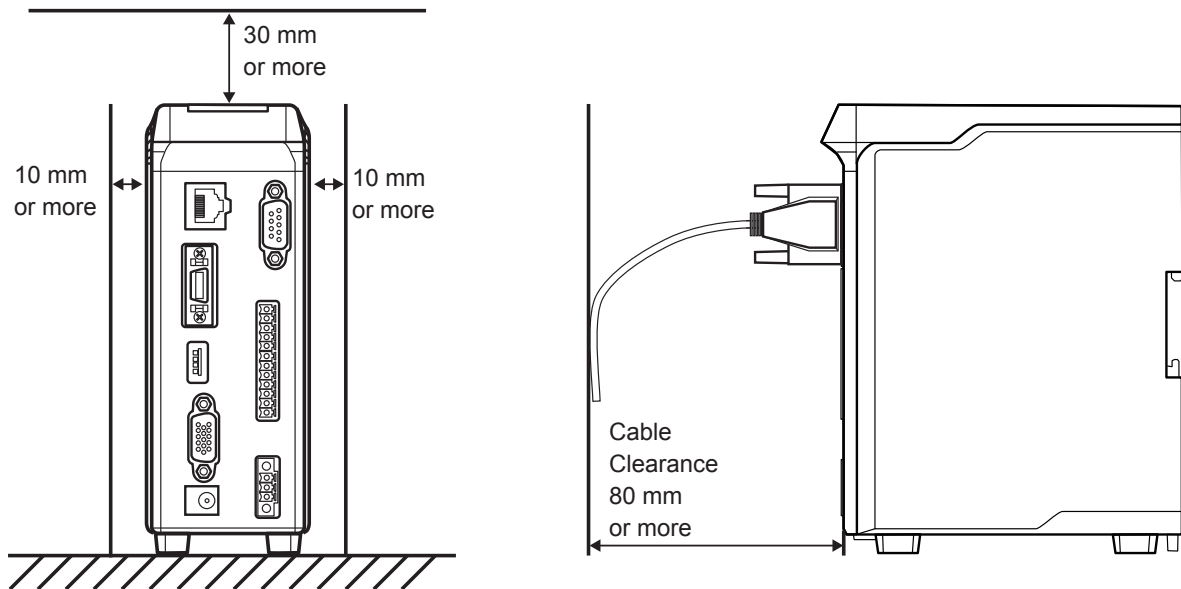

Installation of Each Part

■ Installation of the sensor head

Connect by using the sensor head connection cable.

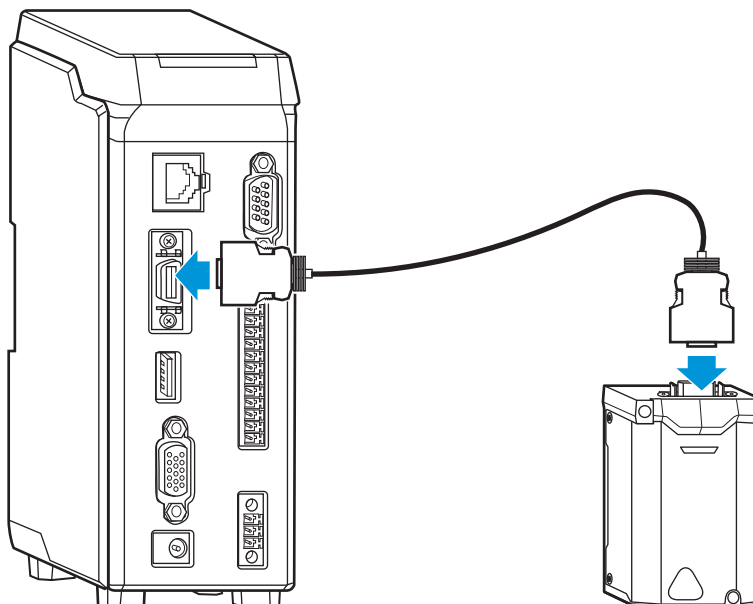

1 Preparations

■ Mount the sensor head to the stand (HA-14)

When using the stand (HA-14), install by following the next steps.

1 Assemble the stand.

Mount the rod on the base of the stand.

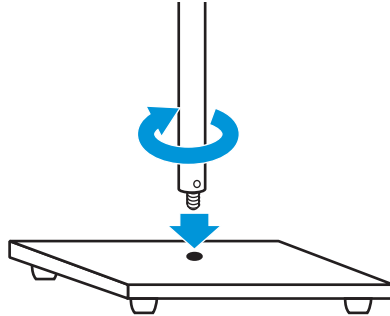

2 Mount the tilt stage to the stand.

Fix the tilt stage with the screws attached to the stand.

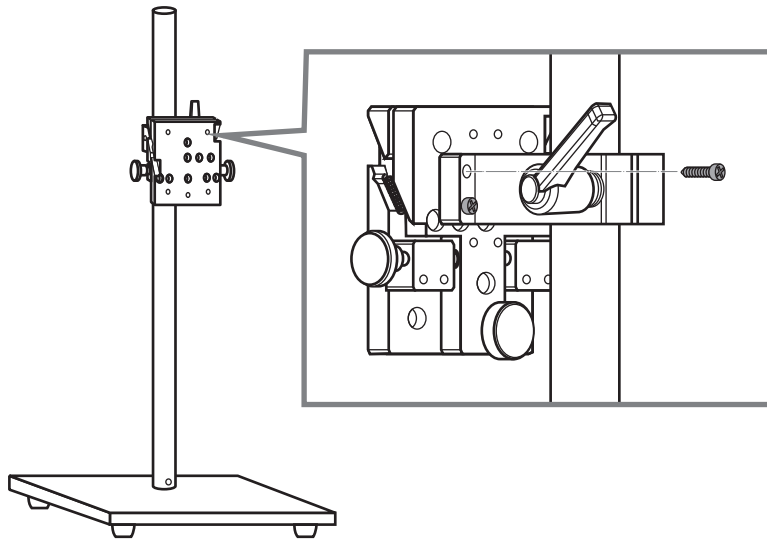

3 Mount the sensor head to the tilt stage.

Fix the sensor head with the screws attached to the tilt stage.

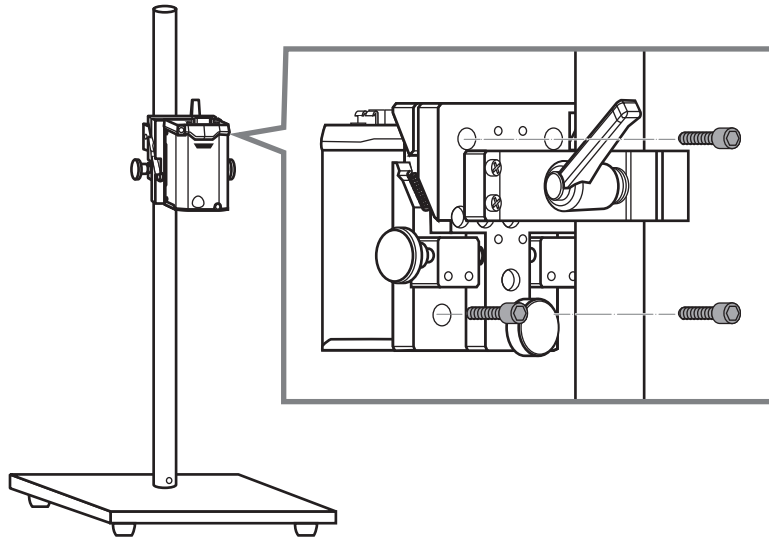

■ Installation of Touch Panel Monitor

Connect the monitor cable, touch panel connection cable, and power source connection cable to the connector respectively.

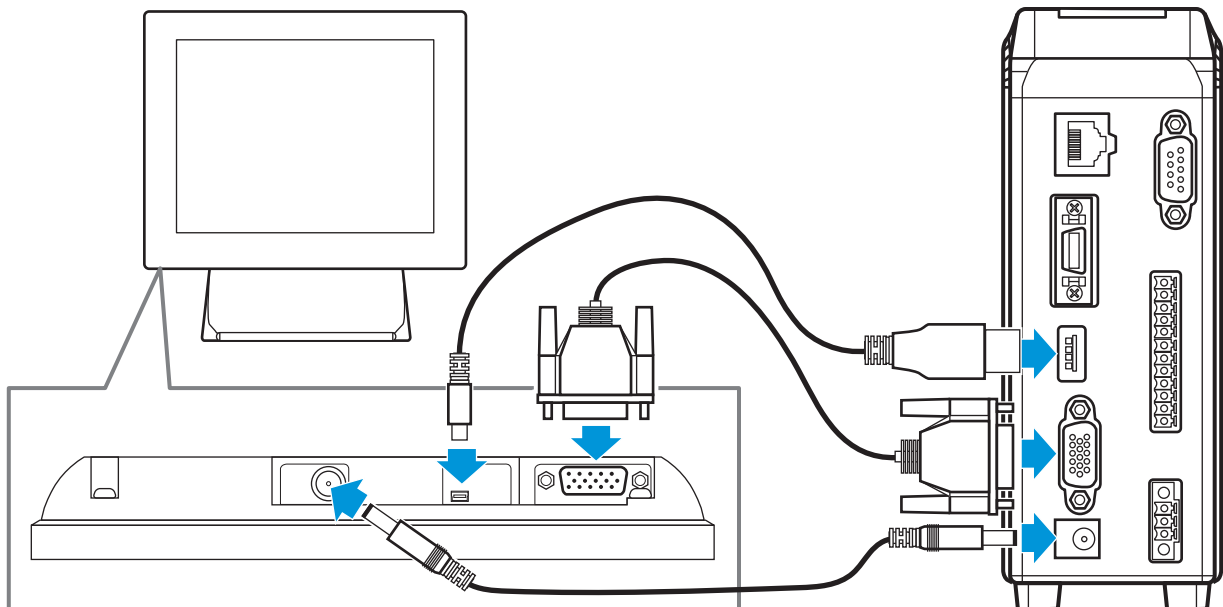

1 Preparations

■ Installation of External Devices

● Installation of PC

Connect by using the RS232C cable or the Ethernet cable.

For details, see “5 Control from External Devices” (→Page 5-1).

● Installation of PLC

Connect to the 12-core connector by using the I/O cable.

For details, see “6 Using Input/Output Terminal” (→Page 6-1).

Applying Power Source

Connect to the power source by using the AC adapter as below.

Or connect DC power supply to 3-pole connector block. See Page 7-2 ■ IPU Rating

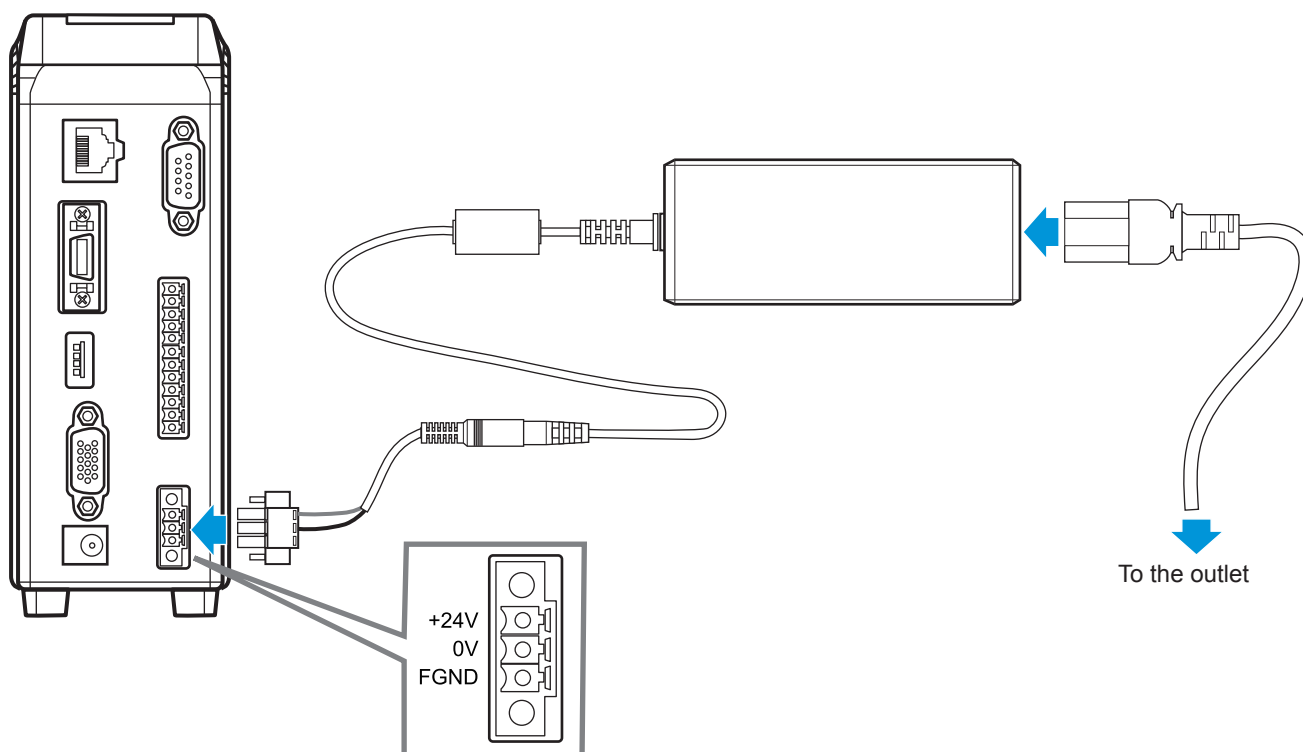

Function Overview

This product is an autocollimator that measure tilting of the target object from the laser light entered to the CMOS (Complementary Metal Oxide Semiconductor) sensor.

It mainly has the following features.

- Able to measure five spots at maximum simultaneously.
- External laser can be used for tilting measurement.
- Operation can be performed with the touch panel monitor. External device is not necessary for various setting.
- Autocollimator can be controlled from external device such as PC.

■ List of Functions

	Function	HPU-500/1000
Angle measurement	Single spot *1	○
	Multi-spot *2	X/● *3
Angle analysis	Area center of gravity	○
	Luminance center of gravity	○
	Luminance peak	○
Convenient function	Luminance value display	○
	Zoom function	○
	Image rotation (XY axis switching)	○
	Image inversion	○
Pass/fail judgment Judgment range	Circle	○
	Square (Rad/Tan)	○
Pass/fail judgment Judgment condition	Offset judgment	○
	Multi-spot Specified spot	○
	Multi-spot All spots	○
DIGITAL I/O	No. of output/input points	Output 4/ Input 8
	Output 1 Common for output signal	○
	Output 2 Judgment result strobe	○
	Output 3 Judgment result	○
	Output 4 Trigger busy	○
	Input 1 Common for input signal	○
	Input 2 Result hold	○
	Input 3 Zero set	○
	Input 4 Measurement start trigger (24V)	○
	Input 5 Laser ON (+)	○
	Input 6 Laser ON (-)	○
	Input 7 Measurement start trigger (+)	○
	Input 8 Measurement start trigger (-)	○
Ethernet	Interface	TCP
	Command control	○
	Data output	CSV format

1 Preparations

	Function	HPU-500/1000
Serial communication	Interface	RS-232C
	Command control	○
	Data output	CSV format

*1: Measure the angle of one specified light spot out of a maximum of 5 light spots.

*2: Measure the angles of all 5 light spots and the relative angles between light spots

*3: HPU-500 is an image processor for single spot measurement only. Sold as a set with the sensor head.

Flow of Measurement

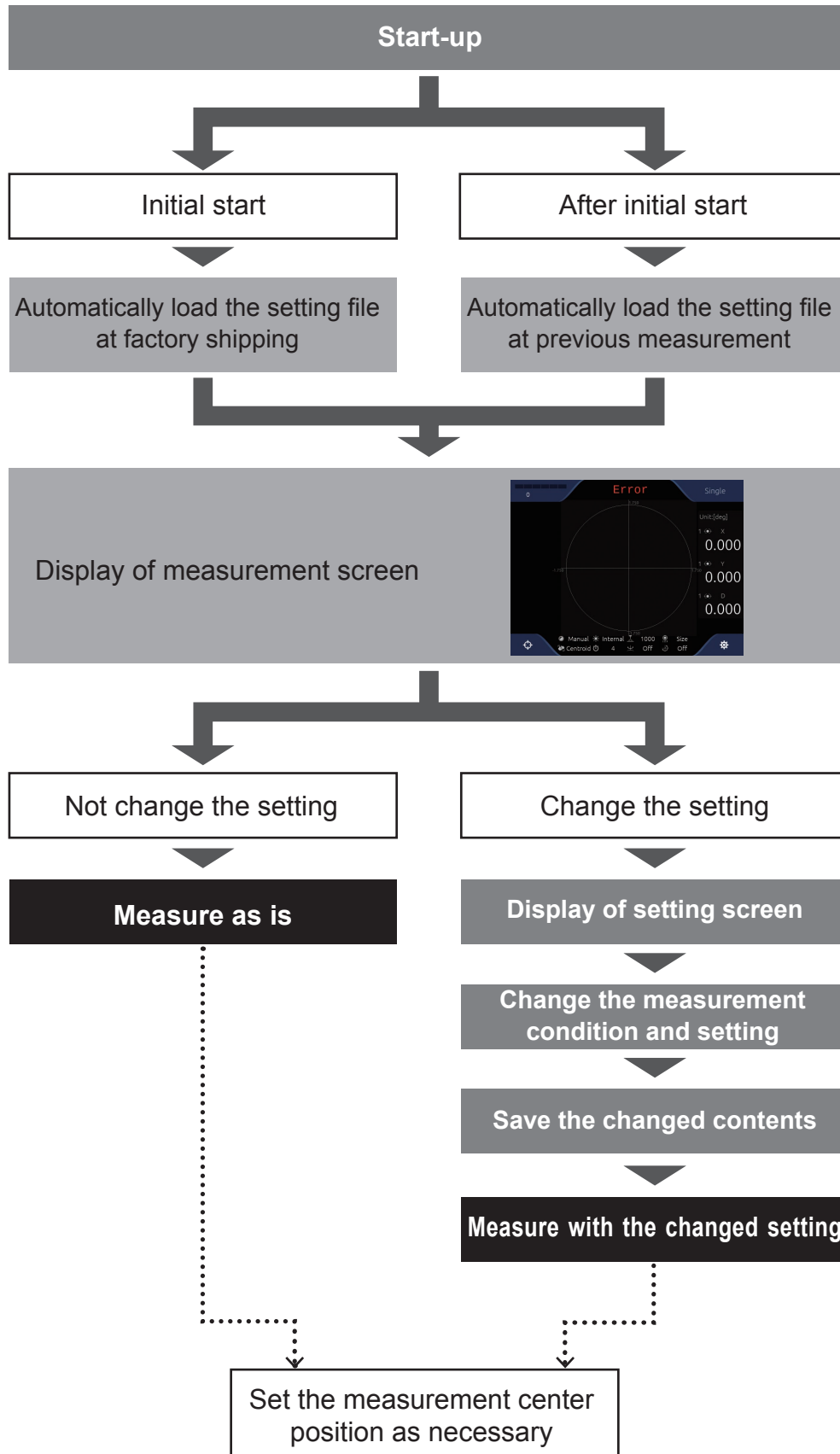

Measurement Procedure



2

Setting

Various settings can be performed and measurement conditions can be changed on the screen by using the touch panel monitor of this product. In this section, the setting method utilizing the GUI is explained.

Setting Method.....	2-2
Use of Setting File	2-7
 Setting of Basic Conditions.....	2-13
 Setting of Detail Conditions.....	2-14
 System Settings.....	2-28

2 Setting

Setting Method

This section describes the basic steps to change the settings and measure after the power is turned on and the outline of the setting items.

■ Basic Flow of Setting

1 Touch (Settings) in the measurement screen.

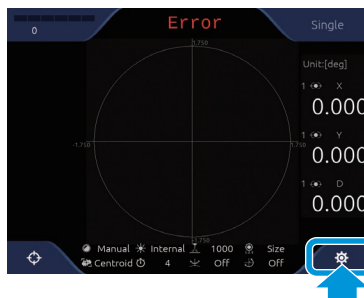

The [Settings] screen is displayed. (→ “■[Settings] Screen Details (Page 2-4)”)

2 Touch a setting item's tab in the menu area to change.

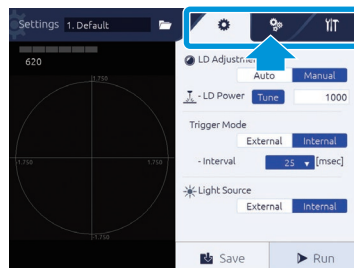

Touch the tab to display the setting content. (→ “■List of Settings Menu (Page 2-5)”)

Info

When changing a setting file to save the changed content, select a setting file first. (→ “Use of Setting File (Page 2-7)”)

3 Enter setting values.

Enter necessary information in each setting content.

For details, see “■Numerical Value Input Method” (Page 2-6)”.

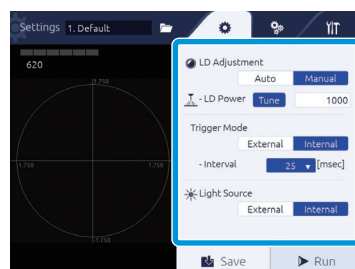

4 After entry is done, touch the [Save] button.

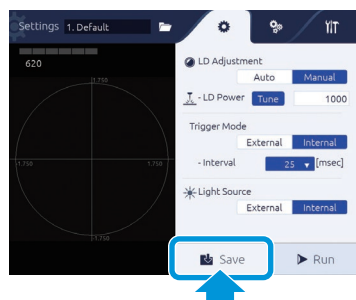

The changed content is saved in the selected setting file.

5 Touch the [Run] button, and measure with the changed content.

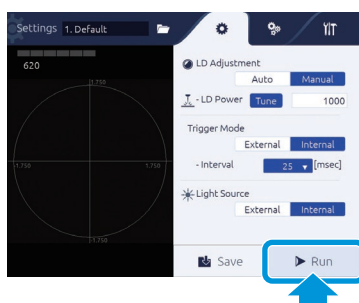

The measurement screen is displayed, and a measurement with the changed content is performed.

Info

- When the setting content is not saved, the confirmation pop-up is displayed to confirm saving.
- The saved setting content can be loaded by reading the setting file. (→ “■Loading of Setting File (Page 2-7)”)

2 Setting

■ [Settings] Screen Details

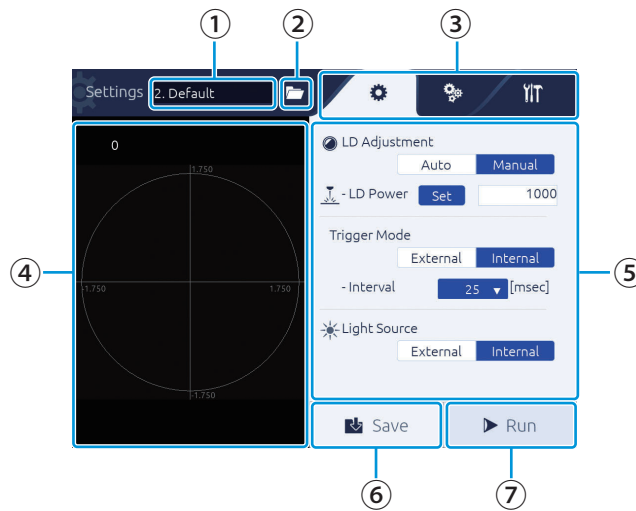

① Setting file name

The currently selected setting file name is displayed. (→Page 2-7)

② (Select File) button

Touch to bring up the dialog and load a setting file. (→Page 2-7)

③ Menu area

The setting item tabs are displayed.

Touch the item to display to display the setting content in ⑤ Setting area.

⚙ Tab: Basic setting

⚙ Tab: Detail setting

⌵ Tab: System setting

④ Image display area

Displays the measurement target.

⑤ Setting area

Displays the setting content.

Touch a numeric input area to display the software keyboard, and the user can enter a value.

⑥ [Save] button



Touch to save the changed content.

⑦ [Run] button

Touch to return to the measurement screen and start measurement.

■ List of Settings Menu

Overview of the setting items and each setting item are shown.

Tab	Group	Item	Overview	Reference
 (Basic condition setting)	-	LD Adjustment	Set the laser strength.	Page 2-13
		Trigger Mode	Set the measurement timing.	
		Light Source	Set the light source of the laser.	
 (Detail condition setting)	Measurement (Setting of measurement conditions)	Mode	Select Single-Spot or Multiple-Spot measurement mode	Page 2-15
		Spot Sorting Rules	Set a number assignment method of the light spot labels.	Page 2-17
		Tolerance	Set the judgment standard area.	Page 2-18
		Detect Mode	Set a detection method of the light spot.	Page 2-22
		Moving Average	Set the number of averaging process for spots intensity.	Page 2-25
	Camera (Sets the camera)	Shutter Speed	Set the exposure time.	Page 2-25
	Display (Sets the display)	Mirroring	Set the mirroring an image.	Page 2-26
		Rotation	Set the rotation an image.	
		Unit	Set the unit for an measurement angle as Degree, Min Sec and m rad	
		Light Spot Pointer	On/Off the screen pointer.	
		Viewing Angle	Set the display field angle	
Auto Zoom	Set the display magnification.			
 (System settings)	Configuration (Settings of system configuration)	Output	Set the output method of an measurement result.	Page 2-30
		Ethernet	Set Ethernet connection details	
		Serial Port	Set the serial communication speed.	
		Command Mode	Set a command mode	
		Strobe	Set the strobe time.	
	Image Output (FTP)	Sets the destination FTP of an image.		
	Calibration (Settings of angle calibration)	Select Calibration Mode	Sets a calibration mode.	Page 2-30
Information (Verification of system information)	-	Verifies system information.	Page 2-30	

2 Setting

■ Numerical Value Input Method

An input method for entering values as the setting values is explained.

1 Touch the numerical entry field.

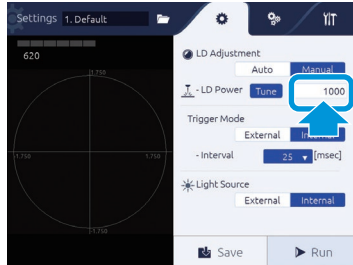

The value input screen is displayed.

2 Select a numerical number input method.

Every time you touch the  icon in the bottom part of the screen, the input method switches.

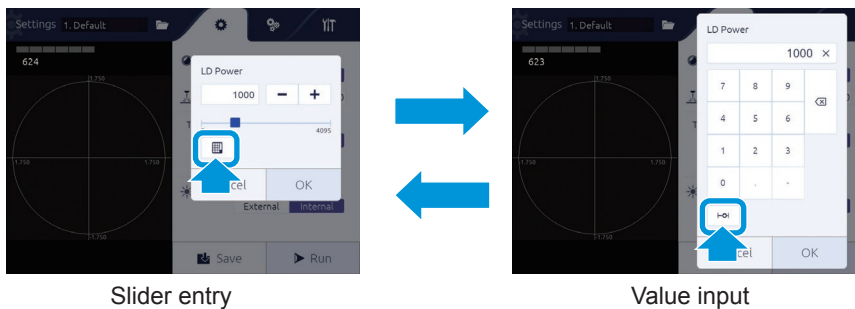

3 Enter a number.

Slider entry

Touch +/- button or touch the slider.

Value entry

Enter a value with the numeric keyboard.

4 Touch the [OK] button.

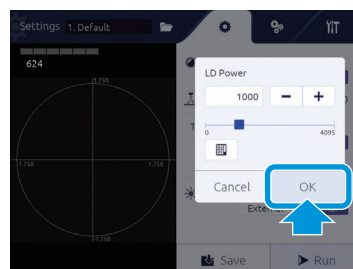

Use of Setting File

The settings can be changed by reading the settings file in which the measurement conditions are saved.

■ Loading of Setting File

1 In the [Settings] screen, touch the  (Select File) button.

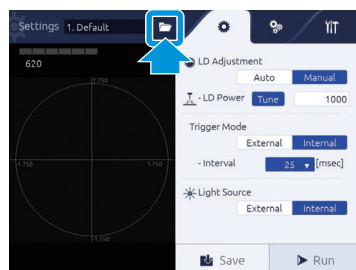

The [Select File] screen is displayed.

[Select File] screen details

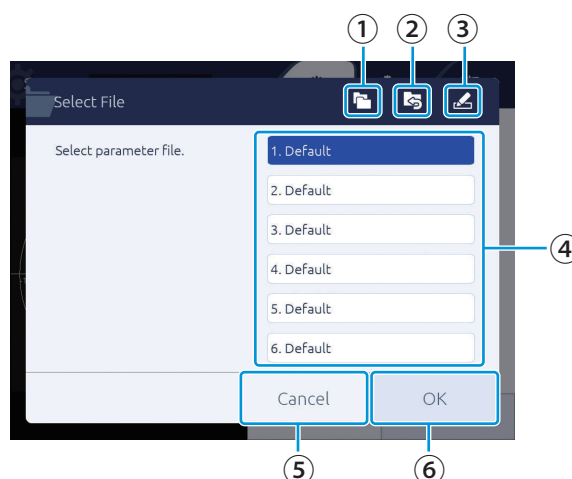

①  (Copy) button

Touch to bring up the dialog and copy a file.

②  (Reset) button

Touch to bring up the dialog and initialize a selected file.

③  (Rename) button

Touch to bring up the dialog and change a file name.

④ **File name area**

The file numbers and file names of the setting files are displayed, and the user can select a setting file.

⑤ **[Cancel] button**

File selection is canceled.

2 Setting

⑥ [OK] button

Execute a setting file loading.

2 Touch a setting file to use.

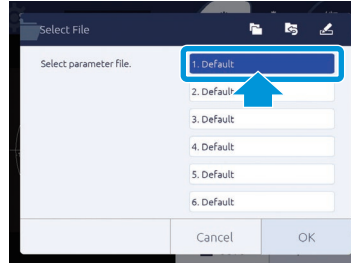

3 Touch the [OK] button.

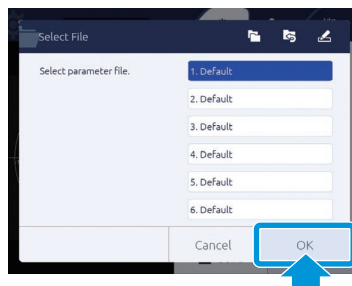

The selected setting file is loaded.

When [Cancel] is touched, the setting file is not changed.

NOTE

When loading a setting file while the setting changes are not saved, [Setting Changed] dialog is displayed. To save the setting and load other file, touch [YES]. Touch [Discard] to cancel changes and load a file. When [Cancel] is touched, loading is canceled.

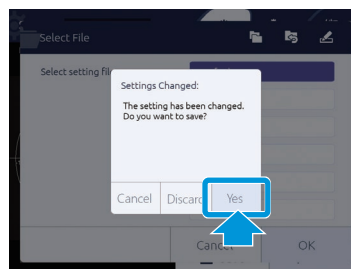

Info

When the power source is applied, it starts with the immediately previous settings.

■ Copying Setting File

A setting file can be copied.

1 In the [Settings] screen, touch the (Select File) button.

The [Select File] screen is displayed.

2 Touch a file to copy.

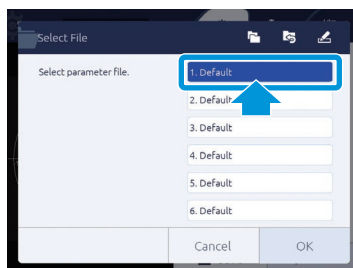

3 Touch the (Copy) button.

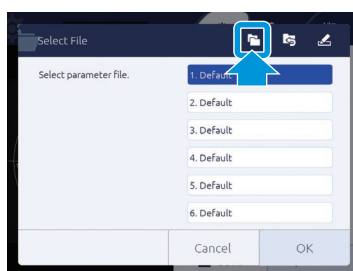

[File Copy Dialog] is displayed.

4 Select a file number to copy to.

Touch the number part in [to], and touch the number applicable in the list.

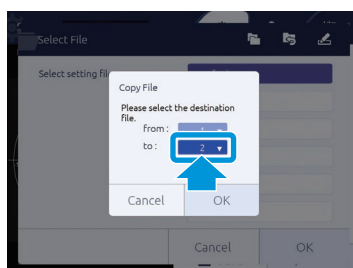

2 Setting

5 Touch the [OK] button.

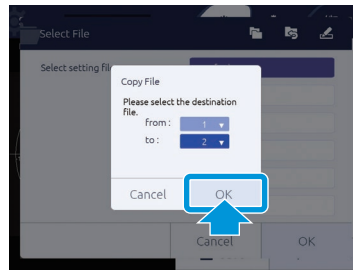

The confirmation screen is displayed.

6 Touch the [OK] button.

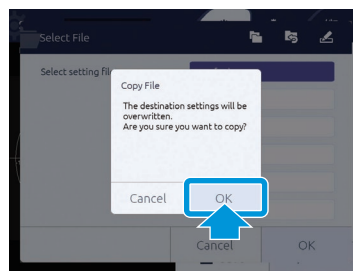

The original settings are copied to the selected file number.
Touch the [Cancel] button to stop copying.

■ Resetting Setting File

The setting file can be reset to the factory setting.

1 In the [Settings] screen, touch the (Select File) button.

The [Select File] screen is displayed.

2 Touch a file to reset.

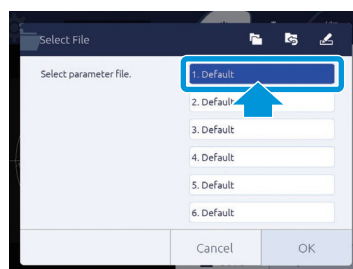

NOTE

Some of setting data may not reset automatically, please refer system setting on “2 Setting”

3 Touch the (Reset) button.

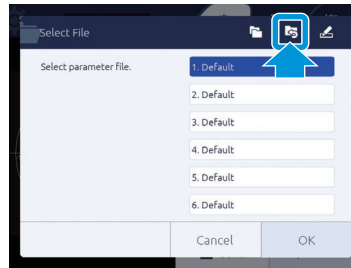

[File Reset Dialog] is displayed.

4 Touch the [OK] button.

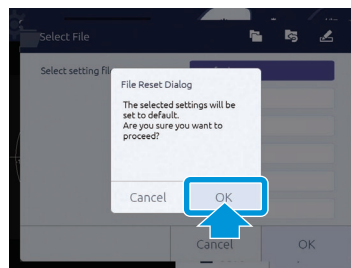

The selected file setting is reset to the factory setting.
Touch the [Cancel] button to cancel resetting.

■ Name Change of Setting File

The name of a setting file can be changed to your choice.

1 In the [Settings] screen, touch the (Select File) button.

The [Select File] screen is displayed.

2 Touch a file to rename.

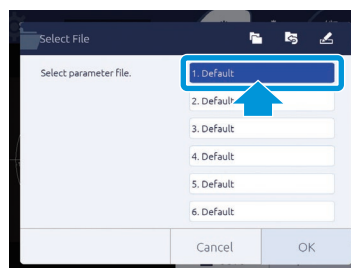

2 Setting

3 Touch the (Rename) button

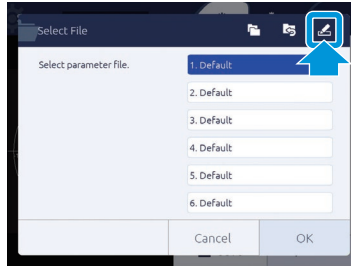

The text input screen is displayed.

4 Enter a file name.

Use the software keyboard to enter.

After entry is done, touch the [Enter] button.

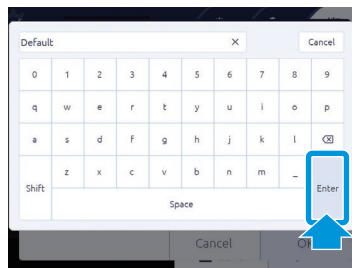

NOTE

- The maximum number of characters that can be entered is 24.
- If no file name is entered, the file cannot be saved.

5 Touch the [OK] button.

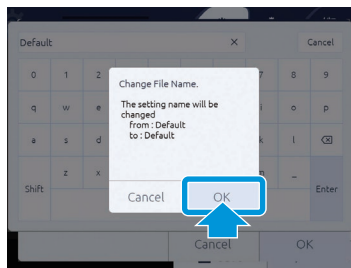

The name of the selected setting file is changed to the entered content.
When [Cancel] is touched, file name change is canceled.

Setting of Basic Conditions

In the  tab, measurement basic conditions such as laser power and laser light source can be set.

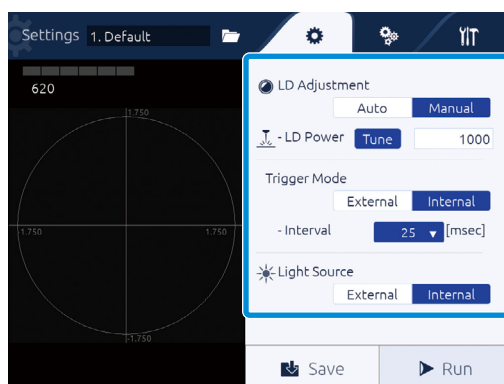

Setting item	Setting value	
LD Adjustment Sets the laser power.	Auto	Adjusts the Laser power automatically. Adjustable range: LDPW 400~3600, Shutter Speed 1~8 Info [Shutter Speed] is changed automatically by [Auto] Mode and cannot be set manually. The automatically set value is a reference value and may not be the optimum value. Also, in cases like the reflectance of the measured object is too high or too low, automatic adjustment may reach its limit and not converge. In that case, please adjust by using [Manual] Mode.
	Manual (def.)	Sets the power with a value. Enter a value in the [LD Power] field to set the power. Touch [Tune] to automatically adjust the power once. Info For details on how to enter numbers, see “Numerical Value Input Method” (Page 2-6)”.
Trigger Mode Sets the measurement timing.	External	The measurement is synchronized by start trigger signal from a external device. Info For DIO signal timing, see “Timing Chart (Page 6-6)”.
	Internal (def.)	The measurement is synchronized by the internal timer and measures continuously. Selects a sampling period from the list.
Light Source Sets the light source of the laser.	External	When [External] is selected, turn off the internal light source and measure the external incident light angle.
	Internal (def.)	When [Internal] is selected, turn on the internal light source and measure the object tilting angle.

def. = default setting

NOTE

When automatic adjustment fails by selecting [Manual] in [LD Adjustment] and touching [Tune], the Warning dialog is displayed. Push the [OK] button to set the value again.



2 Setting

Setting of Detail Conditions

With the  tab, the following contents can be set.

- Setting of measurement conditions [Measurement] (→ Page 2-15)
- Setting of the camera [Camera] (→ Page 2-25)
- Setting of display state [Display] (→ Page 2-26)

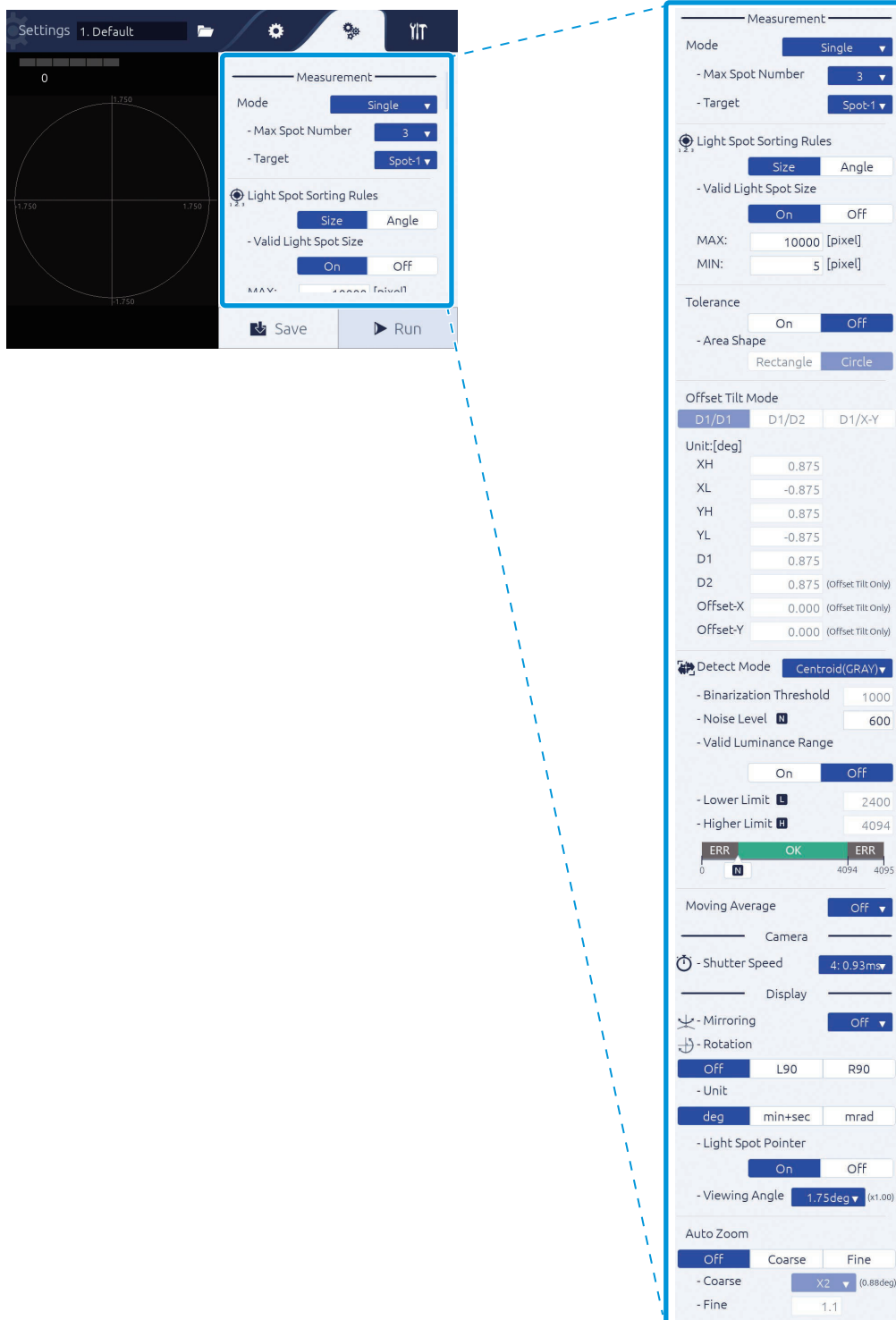

The screenshot displays the software's settings interface. On the left, a main window shows a circular measurement area with a diameter of 1.750. A settings panel is overlaid on this window, and a larger, detailed view of the 'Measurement' settings is shown on the right. The 'Measurement' settings include:

- Measurement**
 - Mode: Single
 - Max Spot Number: 3
 - Target: Spot-1
- Light Spot Sorting Rules**
 - Light Spot Sorting Rules: Size (selected), Angle
 - Valid Light Spot Size: On (selected), Off
 - MAX: 10000 [pixel]
 - MIN: 5 [pixel]
- Tolerance**
 - Tolerance: On (selected), Off
 - Area Shape: Rectangle, Circle (selected)
- Offset Tilt Mode**
 - Offset Tilt Mode: D1/D1 (selected), D1/D2, D1/X-Y
 - Unit: [deg]
 - XH: 0.875
 - XL: -0.875
 - YH: 0.875
 - YL: -0.875
 - D1: 0.875
 - D2: 0.875 (Offset Tilt only)
 - Offset-X: 0.000 (Offset Tilt only)
 - Offset-Y: 0.000 (Offset Tilt only)
- Detect Mode**
 - Detect Mode: Centroid(GRAY)
 - Binarization Threshold: 1000
 - Noise Level N: 600
 - Valid Luminance Range: On (selected), Off
 - Lower Limit L: 2400
 - Higher Limit H: 4094
 - ERR: 0, OK: 4094, ERR: 4095
- Moving Average**
 - Moving Average: Off
- Camera**
 - Shutter Speed: 4: 0.93ms
- Display**
 - Mirroring: Off
 - Rotation: Off (selected), L90, R90
 - Unit: deg (selected), min+sec, mrad
 - Light Spot Pointer: On (selected), Off
 - Viewing Angle: 1.75deg (x1.00)
- Auto Zoom**
 - Auto Zoom: Off (selected), Coarse, Fine
 - Coarse: X2 (0.88deg)
 - Fine: 1.1

■ Setting of Measurement Conditions [Measurement]

In [Measurement], the measurement mode and light spot label assignment can be set.

● Mode

Sets the measurement mode.

For the display of measurement results per measurement mode, see “Verification of Measurement and Judgment Results (Page 3-10)”.

Setting procedure

- ① Select a measurement mode with [Mode].
- ② Set the number of measurement spots (receiving light spot number) with [Max Spot Number].
- ③ Select a spot to be the measurement target (label No.) with [Target].

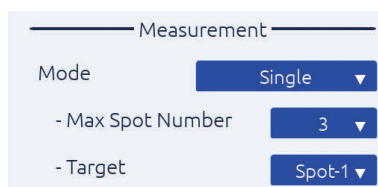

Item description

Setting item	Setting value	
Mode	Single (def.)	Perform measurement and judgment of the selected label No. Setting conditions Max Spot Number: Simultaneously display 3 or more points. Select the display number at this time from 3, 4, or 5. However, if there are less than 3 light spots, only the number of light spots will be displayed. Numbers are assigned to light spots as many as Max number. Target: Select one light spot to measure from Spot1 to Spot5. Info The upper limit of [Target] label No. is the value set in Max Spot Number.
	Offset Tilt	When Offset Tilt is selected, OK/NG judgment can be performed in two different judgment areas by external control (either Ethernet, RS232C, or DIO). For example, if one DUT (Device under test) has two measurement areas, Judgment location can be set individually. Each area can be set using the DIO zero set terminal or command control (RS232C, Ethernet). For setting criteria, see “Offset Tilt Mode (Page 2-20)”.

2 Setting

Setting item	Setting value	
Mode	Multi Relative	<p>The 2 or more receiving light spots (Up to 5 points) are detected, and the relative angle between each spot is measured and judged.</p> <p>Setting range Max Spot number: Simultaneously display 3 or more points. Select the display number from 3, 4, or 5. However, if there are less than 3 light spots, only the number of light spots will be displayed. Spot1 to Spot5 are displayed as many as Max Number. Specify the light points (Spot1 to Spot5) or all light points (All) for angle measurement.</p> <p>Info</p> <ul style="list-style-type: none"> • The measurement results are the inclination about the X axis, the inclination about the Y axis, the inclination with respect to the measurement center, and the relative angle between the receiving light spots. • The determination is made based on the absolute angle value of the specified target, and ERROR is determined when the specified target cannot be received, and NG is determined when the specified target can be received but is outside the determination range. It is NG when designated target is "ALL" and even one point is outside the judgment area.
	Multi Absolute	<p>The 2 or more light spots (Up to 5 points) are detected, and each absolute angle is measured and judged.</p> <p>Setting range Max Spot number: Simultaneously display 3 or more points. Select the display number from 3, 4, or 5. However, if there are less than 3 light spots, only the number of light spots will be displayed. Spot1 to Spot5 are displayed as many as Max Number. Specify the light points (Spot1 to Spot5) or all light points (All) for angle measurement.</p> <p>Info</p> <ul style="list-style-type: none"> • The measurement results are the inclination around the X axis, the inclination around the Y axis, and the absolute angle of inclination with respect to the measurement center for each light receiving spot. • If the specified target is not in the judgment area, an error occurs. If the target is ALL, even one point outside the judgment area is NG.

def. = default setting

● Light Spot Sorting Rules

Sets a number assignment method of the light spot labels.

Setting procedure

- ① In [Spot Sorting Rules], select [Size]/[Angle].
- ② In [Valid Light Spot Size], select [On]/[Off].
- ③ When [On] is selected, the maximum value [MAX] and minimum value [MIN] of the effective light spot size are set.

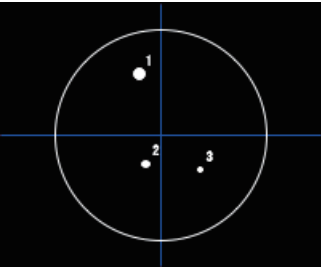
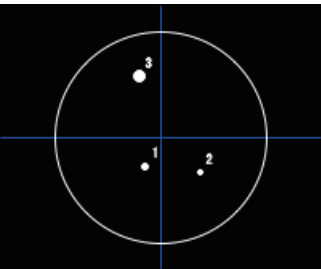

Item description

Setting item	Setting value	
Light Spot Sorting Rules	Size (def.)	Numbers are assigned based on the area size of a light spot (area descending order). 
	Angle	Numbers are assigned in ascending order of angles from the measurement center (angle ascending order). 

def. = default setting

Item description

Setting item	Setting value	
Valid Light Spot Size Sets if the size of a light spot is used for valid/invalid judgment.	On	Uses the size of a light spot for judgment. The size of the light spot is set with [MAX] and [MIN]. If the size is within the range, it becomes valid. Setting range MAX:MIN+1 to 32627 (def.=10000) MIN:1 to MAX-1 (def.=5) Info For the value input method, see “■Numerical Value Input Method” (Page 2-6)”.
	Off (def.)	Do not use the size of a light spot for judgment.

def. = default setting

2 Setting

● Tolerance (Incase of Single, Multi Absolute, Multi Relative)

Set the judgment area(OK/NG).

Setting procedure

- ① In [Tolerance], select [On]/[Off].
- ② In [Area Shape], select [Rectangle]/[Circle].
- ③ When [Rectangle] is selected, set XH/XL/YH/YL.
X-direction maximum value XH, X-direction minimum value XL
Y-direction maximum value YH, Y-direction minimum value YL
- ④ When [Circle] is selected, set the angle of the judgment circle with the radius D1.

Tolerance

On Off

- Area Shape

Rectangle Circle

Offset Tilt Mode

D1/D1 D1/D2 D1/X-Y

Unit:[deg]

XH 0.875

XL -0.875

YH 0.875

YL -0.875

D1 0.875

D2 0.875 (Offset Tilt Only)

Offset-X 0.000 (Offset Tilt Only)

Offset-Y 0.000 (Offset Tilt Only)

Item description

Setting item	Setting value	
Tolerance	On	Enable the judgment area. Set the area in [Area Shape].
	Off (def.)	Disable the judgment area.

def. = default setting

Item description

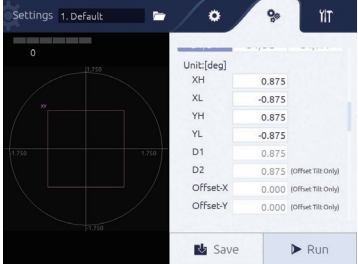
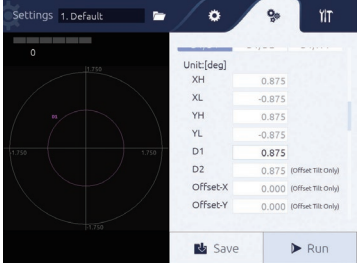
Setting item	Setting value	
<p>Area Shape Sets the judgment standard area.</p>	<p>Rectangle</p>	<p>Set the judgment criteria area to rectangle. Sets the angle to the X and Y direction from the measurement center. Enter values in XH (right direction)/XL (left direction)/YH (upper direction)/YL (lower direction).</p>  <p>Setting range (Unit: deg) XH: XL+0.001 to 1.75 (def.=0.875) XL: -1.75 to XH-0.001 (def.=-0.875) YH: YL+0.001 to 1.75 (def.=0.875) YL: -1.75 to YH-0.001 (def.=-0.875)</p> <p>Setting range (Unit: mrad) XH: XL+0.01 to 30.54 (def.=15.27) XL: -30.54 to XH-0.01 (def.=-15.27) YH: YL+0.01 to 30.54 (def.=15.27) YL: -30.54 to YH-0.01 (def.=-15.27)</p> <p>Setting range (Unit: min+sec) XH: XL+0' 01" to 105' 00" (def.= 52' 30") XL: -105' 00" to XH-0' 01" (def.= -52' 30") YH: YL+0' 01" to 105' 00" (def.= 52' 30") YL: -105' 00" to YH-0' 01" (def.= -52' 30")</p>
	<p>Circle (def.)</p>	<p>Set the judgment criteria area to round. Sets the radius relative to the angle from the measurement center. Enter a value in D1.</p>  <p>Setting range (Unit: deg) D1: 0.001 to 1.75 (def.=0.875)</p> <p>Setting range (Unit: mrad) D1: 0.01 to 30.54 (def.=15.27)</p> <p>Setting range (Unit: min+sec) D1: 0' 01" to 105' 00" (def.= 52' 30")</p>

def. = default setting

*1: When External is selected in "2-13 Light Source", the range of setting values become doubled as below.

Example: Setting range

For Internal: XH XL + 0.001 to 1.75 (def.=0.875)

For External: XH XL + 0.002 to 3.5 (def.=1.75)

2 Setting

● Offset Tilt Mode

Set the measurement criteria when the Mode is set to the Offset Tilt mode.

Setting procedure

In Offset Tilt Mode, can be set two different judgment criteria.

For the second criterion, the judgment area and offset position can be changed with respect to the first criterion.

For example, for the first point, the origin is set to 0 degrees and the judgment area is set to a radius of D1.

At the second point, the origin can be offset while maintaining the radius of D1.

Also change the radius of the second judgment area to D2 or square the area.

If offset is not required, set Offset-X and Offset-Y to "0". Also, offset cannot be set to the first origin.

- ① In [Offset Tilt Mode], select [D1/D1]/[D1/D2]/[D1/X-Y].
- ② When [D1/D1] is selected, set D1/Offset-X/Offset-Y.
When [D1/D2] is selected, set D1/D2/Offset-X/Offset-Y.
When [D1/X-Y] is selected, set XH/XL/YH/YL/D1/Offset-X/Offset-Y.

Tolerance On Off

- Area Shape Rectangle Circle

Offset Tilt Mode
 D1/D1 D1/D2 D1/X-Y

Unit:[deg]

XH 0.875
 XL -0.875
 YH 0.875
 YL -0.875
 D1 0.875
 D2 0.875 (Offset Tilt Only)
 Offset-X 0.000 (Offset Tilt Only)
 Offset-Y 0.000 (Offset Tilt Only)

Item description

Setting item	Setting value
Offset Tilt Mode	D1/D1 (def.) As the judgment area, use the circle with its radius D1 for both first and second DUT(Device Under Test). Enter the offset value of the second measurement center. Setting range (Unit: deg) D1: 0.001 to 1.75 (def.=0.875) Offset-X: -1.75 to 1.75 (def.=0) Offset-Y: -1.75 to 1.75 (def.=0) Setting range (Unit: mrad) D1: 0.01 to 30.54 (def.=15.27) Offset-X: -30.54 to 30.54 (def.=0) Offset-Y: -30.54 to 30.54 (def.=0) Setting range (Unit: min+sec) D1: 0' 01" to 105' 00" (def.= 52' 30") Offset-X: -105' 00" to 105' 00" (def.=0) Offset-Y: -105' 00" to 105' 00" (def.=0)

Setting item	Setting value	
Offset Tilt Mode	D1/D2	<p>As the judgment area, use the circle with its radius D1 for the first DUT and the circle with its radius D2 for the second DUT. Enter the offset value of the second measurement center.</p> <p>Setting range (Unit: deg) D1: 0.001 to 1.75 (def.=0.875) D2: 0.001 to 1.75 (def.=0.875) Offset-X: -1.75 to 1.75 (def.=0) Offset-Y: -1.75 to 1.75 (def.=0)</p> <p>Setting range (Unit: mrad) D1: 0.01 to 30.54 (def.=15.27) D2: 0.01 to 30.54 (def.=15.27) Offset-X: -30.54 to 30.54 (def.=0) Offset-Y: -30.54 to 30.54 (def.=0)</p> <p>Setting range (Unit: min+sec) D1: 0' 01" to 105' 00" (def.= 52' 30") D2: 0' 01" to 105' 00" (def.= 52' 30") Offset-X: -105' 00" to 105' 00" (def.=0) Offset-Y: -105' 00" to 105' 00" (def.=0)</p>
	D1/X-Y	<p>As the judgment area, use the circle with its radius D1 for the first DUT and the rectangular with XY for the second DUT. Enter the offset value of the second measurement center.</p> <p>Setting range (Unit: deg) XH: XL+0.001 to 1.75 (def.=0.875) XL: -1.75 to XH-0.001 (def.= -0.875) YH: YL+0.001 to 1.75 (def.=0.875) YL: -1.75 to YH-0.001 (def.= -0.875) D1: 0.001 to 1.75 (def.=0.875) Offset-X: -1.75 to 1.75 (def.=0) Offset-Y: -1.75 to 1.75 (def.=0)</p> <p>Setting range (Unit: mrad) XH: XL+0.01 to 30.54 (def.=15.27) XL: -30.54 to XH-0.01 (def.= -15.27) YH: YL+0.01 to 30.54 (def.=15.27) YL: -30.54 to YH-0.01 (def.= -15.27) D1: 0.01 to 30.54 (def.=15.27) Offset-X: -30.54 to 30.54 (def.=0) Offset-Y: -30.54 to 30.54 (def.=0)</p> <p>Setting range (Unit: min+sec) XH: XL+0' 01" to 105' 00" (def.= 52' 30") XL: -105' 00" to XH-0' 01" (def.= -52' 30") YH: YL+0' 01" to 105' 00" (def.= 52' 30") YL: -105' 00" to YH-0' 01" (def.= -52' 30") D1: 0' 01" to 105' 00" (def.= 52' 30") Offset-X: -105' 00" to 105' 00" (def.=0) Offset-Y: -105' 00" to 105' 00" (def.=0)</p>

def. = default setting

*1: When External is selected in "2-13 Light Source", the range of setting values become doubled as below.

Example: Setting range

For Internal: XH XL + 0.001 to 1.75 (def.=0.875)

For External: XH XL + 0.002 to 3.5 (def.=1.75)

2 Setting

● Detect Mode

Select the center of gravity position from the center of the light spot area, the luminance center of gravity, and the peak position.

Setting procedure

① In [Detect Mode], select [Center (BIN)]/[Centroid (GRAY)]/[Peak].

② When [Center (BIN)] is selected, Binarization Threshold can be set.

When [Centroid] is selected, Noise Level and Valid Luminance Range can be set.

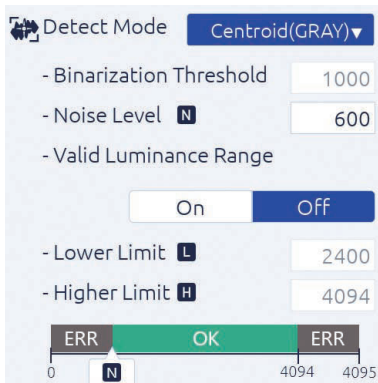



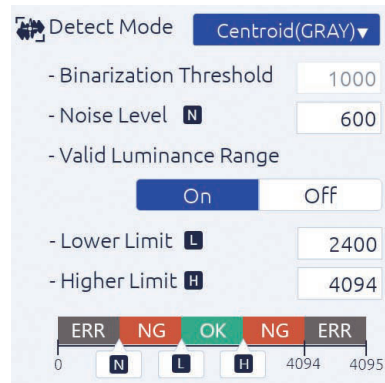



[Valid Luminance Range] is [Off]

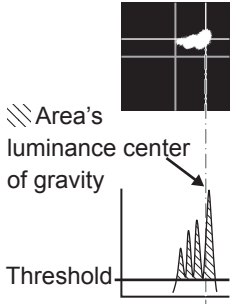

[Valid Luminance Range] is [On]

Item description

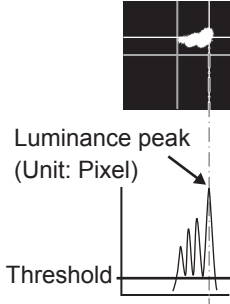
Setting item	Setting value	
Detect Mode	Center (BIN)	<p>In the case of area centroid, the area centroid position is calculated from pixel values higher than the threshold and displayed as an angle.</p> <p>Increasing the threshold can reduce the effect of the peak profile tail.</p> <p>Enter a binary threshold to [Binarization Threshold].</p> <ul style="list-style-type: none"> ■ Detection example <div style="display: flex; align-items: center;">  <div style="margin-left: 10px;"> <p>/// Area's area center of gravity</p> </div> </div> ■ Recommended measurement target <p>Objects that do not blur due to reflection with a uniform surface such as the mirror surface. The blur refers to things such as the profile being uneven and not smooth.</p> <ul style="list-style-type: none"> · Mirror <div style="display: flex; align-items: center;">  </div> · Glass <div style="display: flex; align-items: center;">  </div>

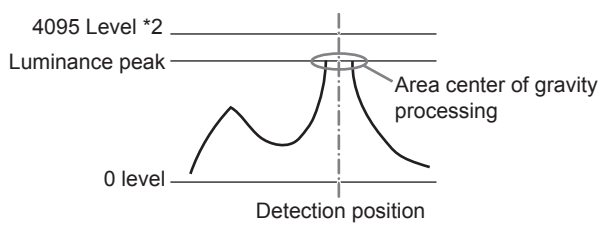
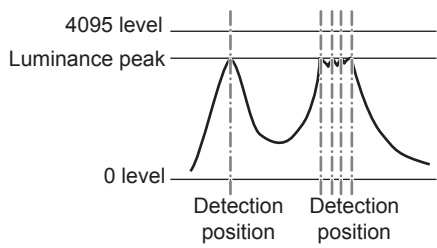
Setting item	Setting value	
Detect Mode	Centroid (GRAY) (def.)	<p>An angle is calculated based on the luminance weighed center of gravity formula of valid pixels that luminance is higher than the noise level. Enter a noise level in [Noise Level] that becomes valid.</p> <p>■ Detection example</p>  <p>Area's luminance center of gravity</p> <p>Threshold</p> <p>■ Recommended measurement target</p> <p>When the light point is blurred due to reflection from an object with an uneven surface such as a resin surface.</p> <ul style="list-style-type: none"> · Lens (on horizontal surface part) 
	Peak	<p>The position of maximum luminance is detected.</p> <p>■ Detection example</p>  <p>Luminance peak (Unit: Pixel)</p> <p>Threshold</p> <p>■ Recommended measurement target</p> <ul style="list-style-type: none"> · Lens (on horizontal surface part)  <p>When the pixel of the maximum luminance is continuous, its area center of gravity is detected. (*1)</p> <p>In case of *1</p>  <p>4095 Level *2</p> <p>Luminance peak</p> <p>0 level</p> <p>Detection position</p> <p>Area center of gravity processing</p> <p>*2 Measurement is done in 12bit. So the maximum value is 4095.</p> <p>When there are multiple pixels of the maximum luminance and they are not continuous, it becomes an error. (*3)</p> <p>In case of *3 (Error)</p>  <p>4095 level</p> <p>Luminance peak</p> <p>0 level</p> <p>Detection position</p> <p>Detection position</p> <p>NOTE</p> <p>It supports when the Mode is Single Spot.</p>

def. = default setting

2 Setting

Item description

Setting item	Setting value	
Binarization Threshold When [Center (BIN)] is selected, the binary threshold is set.	-	Setting range 600 to 4095 (def.=1000) NOTE When the number of valid pixels exceeds 32767, it becomes an error.
Noise Level When [Centroid (GRAY)] is selected, set the noise level that becomes a reference.	-	It becomes invalid when it is less than the set noise level. Setting range 600 to Lower Level-1 (def.=600)
Valid Luminance Range When [Centroid (GRAY)] is selected, it is set to make the maximum luminance judgment valid.	On	Enables maximum intensity judgment. The range is set with [Lower Level] and [Higher Level]. Setting range Lower Limit: Noise Level+1 to Higher Limit-1 (def.=2400) Higher Limit: Lower Limit+1 to 4095 (def.=4094)
	Off (def.)	Set the maximum luminance judgment to invalid

def. = default setting

*1: The luminance intensity range can be set when measuring the spot.

For example, when the intensity of the target spot is unstable, both upper and lower limit intensity can be set. Then this eliminate both too strong and too week intensities spots.

Info

Judgment image when [Valid Luminance Range] is [On].



When the maximum luminance judgment is valid, the setting range of N, L, and H are as follows.

Luminance value $600 \leq N < L < H \leq 4095$ (When $L < N$, change N to L-1)

Judgment image when [Valid Luminance Range] is [Off].

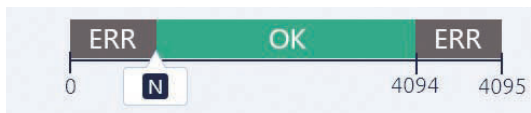

When the maximum luminance judgment is invalid, the setting range of N is as follows.

Luminance value $600 \leq N \leq 4095$

● Moving Average

Set judgment value for number of averaging (moving average).

Moving Average Off ▼

Item description

Setting item	Setting value
Moving Average	- Set judgment value for number of averaging. Setting range 2/4/8/16/Off (def.) Info When a measurement becomes Error or NG, the number of processes is set to 1, and it is counted again.

def. = default setting

■ Settings of Camera [Camera]

Perform settings of camera.

Camera

⌚ - Shutter Speed 4: 0.93ms▼

Item description

Setting item	Setting value
Shutter Speed *1 Sets the exposure time. NOTE It is invalid when LD output auto-adjustment. (→ Page 2-13)	- Sets the exposure time. Setting range 1 to 8 (def.=4) Info Each exposure time of 1 to 8 is as follows. 1: 0.09 ms / 2: 0.20 ms / 3: 0.43 ms / 4: 0.93 ms / 5: 2.00 ms / 6: 4.31 ms / 7: 9.28 ms / 8: 20.00 ms

def. = default setting

*1: When the luminance intensity is too strong or too weak, the appropriate brightness can be obtained by changing the exposure time of the camera.

2 Setting

■ Settings of Display State [Display]

Display settings such as the display method and unit are set.

The screenshot shows the 'Display' settings interface. It features several sections:

- Mirroring:** A dropdown menu set to 'Off'.
- Rotation:** A dropdown menu with options 'Off', 'L90', and 'R90'.
- Unit:** A dropdown menu with options 'deg', 'min+sec', and 'mrad'.
- Light Spot Pointer:** A toggle switch set to 'On'.
- Viewing Angle:** A dropdown menu set to '1.75deg' with a multiplier '(x1.00)'.
- Auto Zoom:** A dropdown menu with options 'Off', 'Coarse', and 'Fine'.
- Coarse:** A dropdown menu set to 'X2' with a multiplier '(0.88deg)'.
- Fine:** A text input field containing '1.1'.

Item description

Setting item	Setting value	
Mirroring Sets the mirroring display of an image.	Off (def.)	No flip
	X	Flip horizontally
	Y	Flip upside down
	X/Y	Flip horizontally and upside down
Rotation Sets the rotation display of an image.	Off (def.)	No rotation display.
	L90	Rotate 90° counterclockwise with the display coordinate origin spot as the center.
	R90	Rotate 90° clockwise with the display coordinate origin spot as the center.
Unit Sets the display unit of an measurement value's angle.	deg (def.)	Use degree unit.
	min+sec	Use minutes and seconds units.
	mrاد	Use milliradian unit.
Info The data to send the host device also use same unit.		
Light Spot Pointer Sets the display method of the pointer.	On (def.)	A cross line is displayed on the light spot.
	Off	No cross line is displayed.
Viewing Angle Sets the pseudo vision field angle display.	-	Setting range (Unit: deg) 1.75 (def.)/1.00/0.50/0.25
		Info According to the selected angle, an image is zoomed in.

Setting item	Setting value	
Auto Zoom Sets the display magnification. Info The data to send the host device also use same unit.	Off (def.)	No zoom in display is performed.
	Coarse	Set the magnification from the specified choices. Setting range × 2 (def.)/×4/×8
	Fine	Set the magnification of your choice. Setting range 1.1 to 8.0 (def.=1.1)

def. = default setting

Info

When zoom is valid, the following functions are performed.

- When a label No. is selected, automatically zoom in if the applicable label light spot is in the zoom-in range.
- When a label All is selected, automatically zoom in if all target light spots are in the zoom-in range.
- While zooming in, "ZOOM" is displayed on the monitor screen.
- When the judgment range is outside (wide) the zoom-in display range, no judgment frame display since it is judged as within all screen judgment range.
- Display the judgment range center with a light blue line.
- When a judgment range is a rectangle, zoom-in with the center of gravity of the rectangle area (≠ judgment center) as reference.
- According to the zoom-in magnification, the zoom-in display size is displayed with a yellow lined rectangle.

2 Setting

YIT System Settings

With the YIT tab, the following items can be set.

- Settings of System Configuration [Configuration]
- Settings of angle calibration [Calibration]
- Verification of system information [Information]

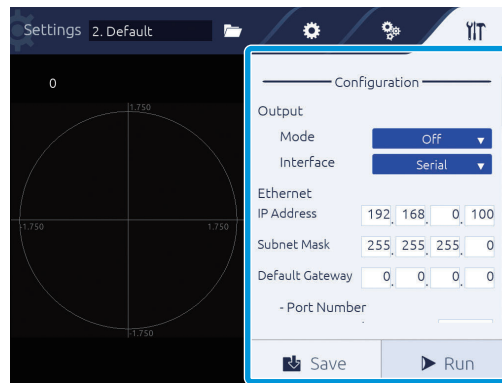

■ Settings of System Configuration [Configuration]

Able to set communication connection and command mode.

A detailed view of the 'Configuration' window. It is titled 'Configuration' and contains several sections:

- Result Output:** Mode (Off), Interface (Serial).
- Ethernet:** IP Address (192, 168, 0, 100), Subnet Mask (255, 255, 255, 0), Default Gateway (0, 0, 0, 0).
- Port Number:** Command (8000), Data Output (8001).
- Serial Port:** Baudrate (115200).
- Command Mode:** Normal (selected), HIP1200.
- Tarminal Output Strobe:** Delay Time (5 [msec]), Pulse Width (10 [msec]).
- Image Output (FTP):** On (selected), Off.
- FTP Settings:** IP Address (192, 168, 0, 2), User Name (ss_ipu), Password (1234), Upload Folder (/ftp).

Item description

Setting item	Setting value	
Result Output - Mode Sets the output method of an measurement result.	Off (def.)	No output.
	Stream	Measurement results are always output.
	IO	Measurement results are output when the Hold command is entered.
Result Output - Interface Sets the output interface of an measurement result.	Serial (def.)	Measurement results are output to the serial communication.
	Ether	Measurement results are output to the Ethernet communication.
Ethernet Sets the environments of Ethernet such as connection settings.	IP Address	Setting range 0.0.0.0 to 255.255.255.255 (def.=192.168.0.100)
	Subnet Mask	Setting range 0.0.0.0 to 255.255.255.255 (def.=255.255.255.0)
	Default Gateway	Setting range 0.0.0.0 to 255.255.255.255 (def.=0.0.0.0)
	Port Number - Command	Sets the port number for command sending/receiving. Setting range 1024 to 65534 (def.=8000)
	Port Number - Data Output	Automatically sets the port number for data output. Sets the port number + 1 for command sending/receiving. (def.=8001)
Serial Port Sets the serial communication speed.	Baudrate	Setting range 9600/19200/38400/57600/115200 (def.)
Command Mode Sets a command mode to use.	Normal (def.)	Uses a current mode.
	HIP1200	Uses the HIP-1200 command mode.
Terminal Output Strobe Sets the strobe time.	Delay Time	Sets the time from the measurement result output start to Strobe launching is done after an image processing is done. Setting range 1 to 999 ms (def.= 5 ms) NOTE Set for the Delay Time + Pulse Width is 1,000 ms or less.
	Pulse Width	Sets the time from Strobe launch to Strobe powering down. Setting range 1 to 999 ms (def.=10ms) NOTE Set for the Delay Time + Pulse Width is 1,000 ms or less.
Image Output (FTP) Sets the sending method of image data.	On	Sends image data with Ethernet. Sets the following information of the destination FTP server. - IP Address - Username - Password - Upload Folder Info The format of images to be sent is as follows. • Image format: PNG format • Output file name: lac_rawimage_XXXXX.png XXXXX is a serial number and the maximum value is 99999. When it reaches the maximum value, it returns to 00000.
	Off (def.)	No image data is sent with Ethernet.

def. = default setting

Continued to next page

2 Setting

Info

The image of Strobe signal movement is as follows.

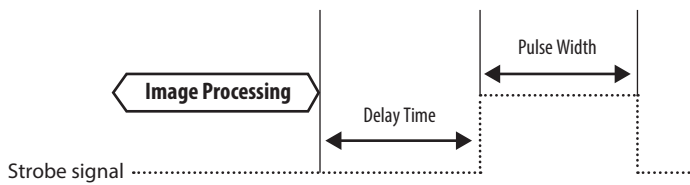

■ Settings of Angle Calibration [Calibration]

Touch the [Calibration] button to perform angle calibration.

For details of angle calibration, see “4 Angle Calibration” (Page 4-1).

Calibration

Calibration Profile

Factory Custom

Zero Position

- X : [pixel]

- Y : [pixel]

Calibration Value

- Angle : [deg/pixel]

■ Verification of System Information [Information]

The model name of the head unit and IPU, and serial number can be verified.

Information

Head

Model : H410-175R

Serial Number : 000001281405-4

Software Version : 00.01.00.00

Image Processing Unit

Model : HPU-1000

Serial Number : 21255116-A020

Software Version : 00.01.00.00

MAC address : xx-xx-xx-xx-xx-xx

3

Measuring

In this product, measurement results are displayed on the touch panel monitor. In this section, measurement settings, and how to view the measurement screen and measurement results are explained.

Overview of Measurement Screen	3-2
Settings of the Measurement Mode	3-4
Settings of the Judgment Area	3-6
Verification of Measurement and Judgment Results ...	3-10

3 Measuring

Overview of Measurement Screen

In this product, after power source is applied, the specific data are read, which is displayed on the measurement screen, and a measurement starts.

Here, how to view the measurement screen is explained.

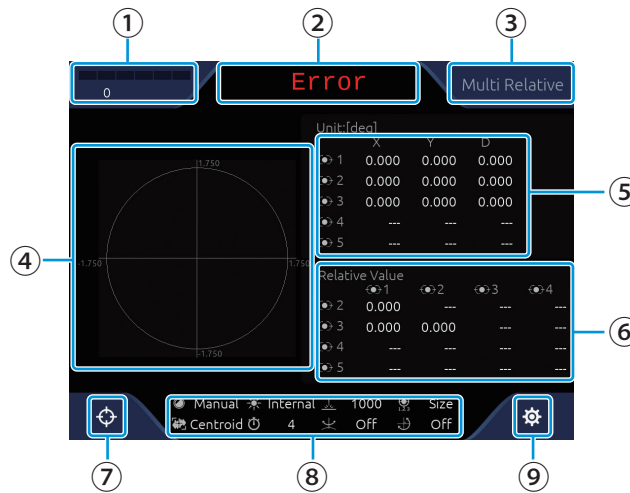

* The picture shows when the measurement mode is "Multi Relative".

① Light quantity of light reception display

Received light level is as follows.

Level display	State	Content
	Under (Error)	Measurement is not possible because the brightness level set for each Detect Mode has not been reached. <ul style="list-style-type: none"> Center (BIN): Binary threshold Centroid (Gray): Noise level Peak: Luminance value less than 600
	Weak	Measurement is possible, but measurement becomes unstable due to low luminance.
	Adequate	Luminance adequate for measurement.
	Best	Luminance best for measurement.
	Strong	It is measurable, but the brightness is starting to saturate.
	Over (Error)	Due to too many saturated pixels to measure, measurement can not be done. The number of pixels with 4095 or more is: <ul style="list-style-type: none"> Centroid (GRAY)/Peak: 3 pixels or more Center (BIN): 32768 pixels or more

Under normal conditions, the level display, which indicates the received light level status, is displayed continuously in both bar display and brightness. However, there are cases where only the luminance value is displayed without displaying the bar, so the example is described below.

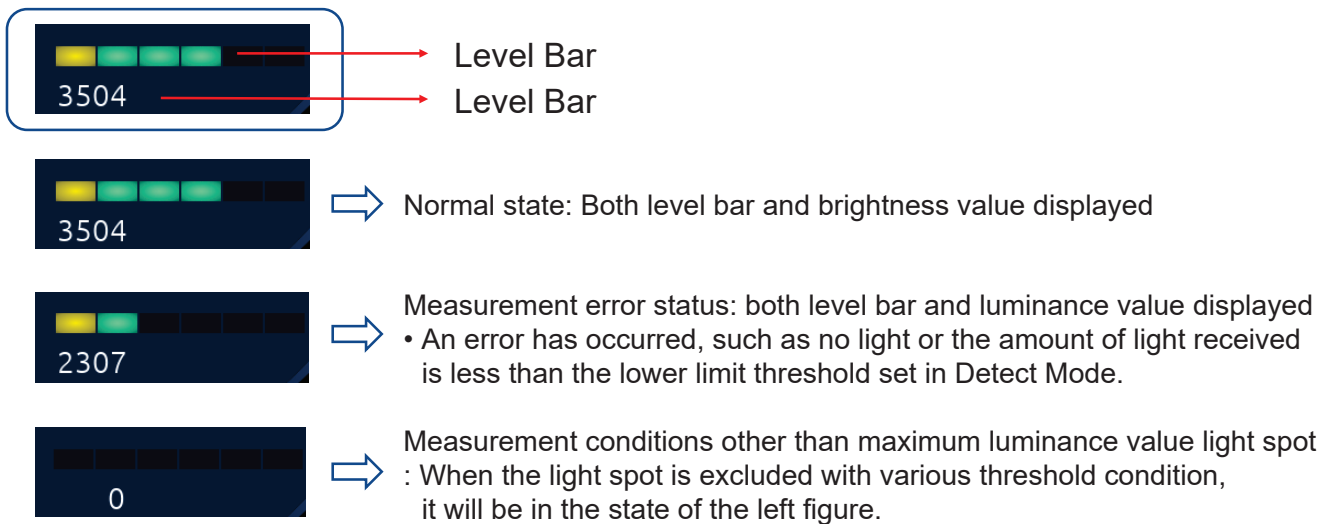

② Display of measurement judgment

Measurement judgment results are displayed in the following contents.

In case of OK: OK (green)

In case of NG: NG (red)

In case of Error: Error (red)

③ Measurement mode display

A measurement mode during setting is displayed.

④ Camera image display

A camera image is displayed.

⑤ Incident light measurement result (absolute value)

The measurement center and the angle (Tilt) about the X and Y axis of each light receiving spot are displayed.

The display units selected in the [Unit] settings are used (→ Page 2-26).

⑥ Incident light measurement result (relative value)

The surface's angle that is generated with multiple spots is displayed.

⑦ (Zero set) button

Touch this button to define the light point spot position as the measurement center. Touch this button again to revert the center point as the measurement center.

NOTE

Moving the origin changes the measurement range.

For example, shifting the origin by +0.5 degrees shifts the angular range by +0.5 degrees.

e.g.

-1.75 to +1.75 degrees => -1.25 to +2.25 degrees

When [Detect Mode] (→ Page 2-22) is [Center (BIN)] or [Centroid (GRAY)], the center position may change.

3 Measuring

⑧ Setting value display

The setting state of the following items is displayed.

LD Adjustment, Light Source, LD Power, Spot Sorting Rules, Detect Mode, Trigger Interval, Mirroring, and Rotation

⑨ ⚙️ (Settings) button

Touch this button to display the [Settings] screen (→ Page 2-2).

Settings of the Measurement Mode

The measurement and judgment criteria differ depending on the measurement mode.

To change the measurement mode, perform the following procedure. For detail setting, see Page 2-15.

1 Touch ⚙️ (Settings) in the measurement screen.

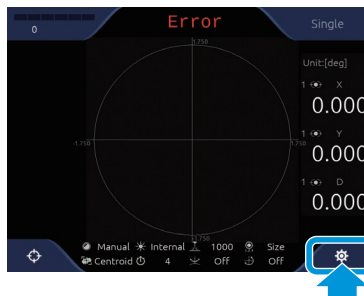

The [Settings] screen is displayed.

2 In the menu area, touch the ⚙️ (Detail settings) tab.

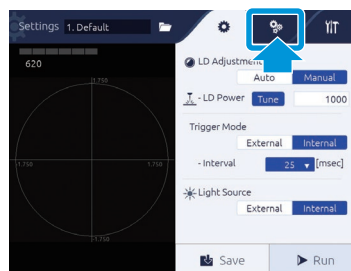

3 Select a measurement mode with [Mode].

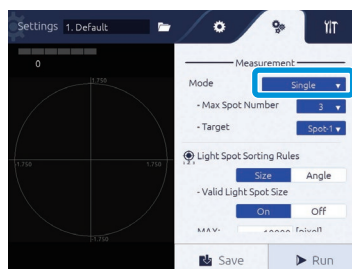

- 4 Set the number of measurement spots with [Max Spot Number], and set the judgment target spot with [Target].

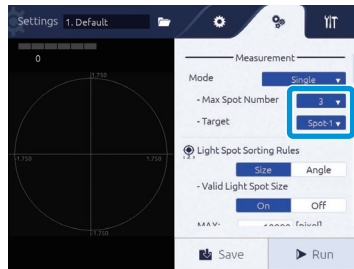

- 5 Touch the [Run] button.

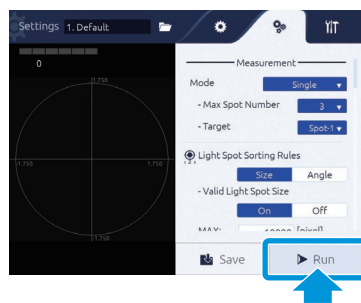

It returns to the measurement screen.

Info

When saving the settings, touch the [Save] button before touching the [Run] button.

3 Measuring

Settings of the Judgment Area

When setting an allowable limit for the measurement result, set a reference judgment area. To set the judgment area, refer following the procedure as below. For details of setting contents, see Page 2-18.

Depending on a measurement mode, the setting method of judgment standards differs.

● When the measurement mode is Single, Multi Absolute, and Multi Relative

To make a judgment, setting the judgment area can be needed.

1 Touch (Settings) in the measurement screen.

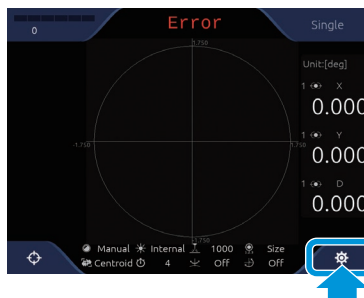

The [Settings] screen is displayed.

2 In the menu area, touch the (Detail settings) tab.

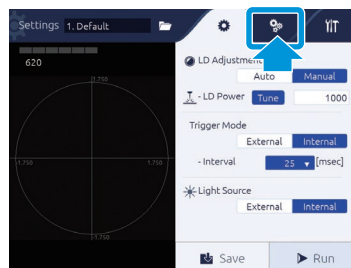

3 In [Tolerance], select [On].

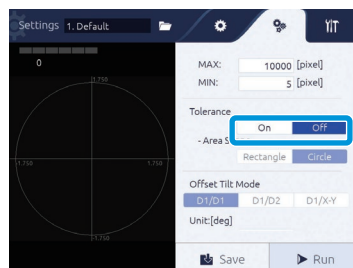

4 In [Area Shape], select [Rectangle]/[Circle].

In case of [Rectangle], judgement area is set at Center with Rectangle shape.

In case of [Circle], judgement area is set at Center with Circle shape.

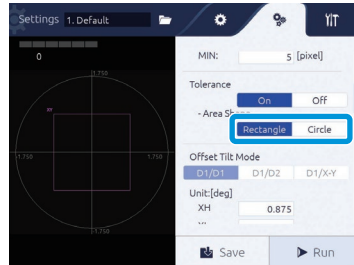

5 Set the size of the judgment area.

When [Rectangle] is selected, set the right and left side with XH/XL, and top and bottom with YH/YL.

In case of [Circle], set the radius with D1.

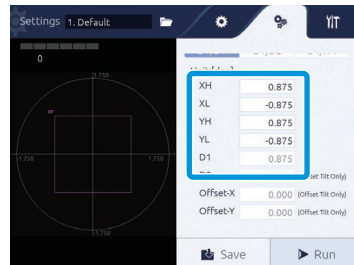

6 Touch the [Run] button.

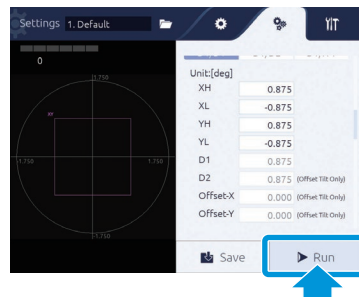

It returns to the measurement screen.

3 Measuring

● The Measurement Mode is Offset Tilt

In case of the Offset Tilt, judgment is always done.

1 Touch (Settings) in the measurement screen.

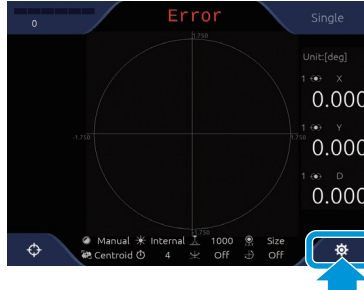

The [Settings] screen is displayed.

2 In the menu area, touch the (Detail settings) tab.

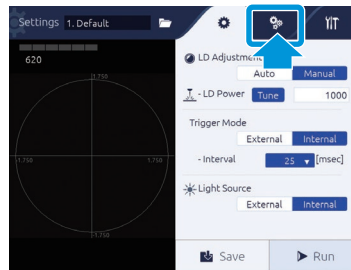

3 In [Offset Tilt Mode], select [D1/D1]/[D1/D2]/[D1/X-Y].

In case of [D1/D1], use the circle with the same radius is the judgment area for both first and second times.

In case of [D1/D2], use the circle with the different radius for the first time and second time is the judgment area.

In case of [D1/ X-Y], use the circle for the first time and the rectangle for the second time as the judgment area.

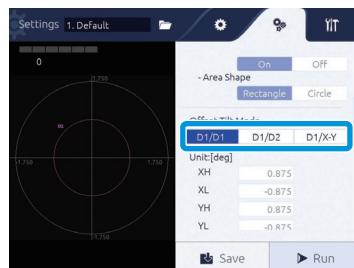

4 Set the size of the judgment area.

In case of [D1/D1], set the radius with D1.

In case of [D1/D2], set the radius with D1 and D2.

In case of [D1/X-Y], set the radius with D1, the right and left side with XH/XL, and top and bottom with YH/YL.

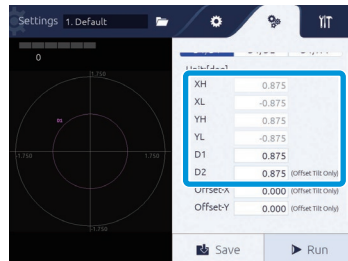

5 Set the measurement center of the second time.

Set the right and left direction movement with Offset-X, and the top and bottom direction movement with Offset-Y.

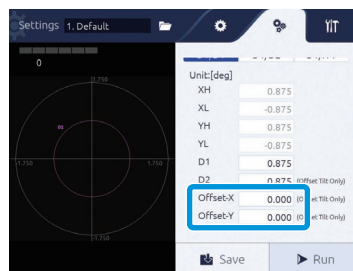

6 Touch the [Run] button.

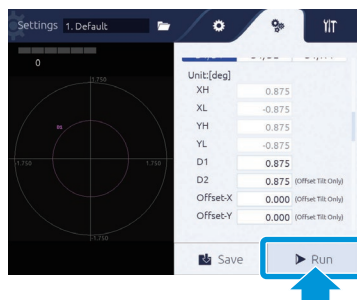

It returns to the measurement screen.

3 Measuring

Verification of Measurement and Judgment Results

The measurement and judgment criteria differ depending on the measurement mode.

In this section, the measurement results per mode and calculation method of judgment results are explained.

Info

In case of below, the judgment becomes "Error".

- The light spot is not in the measurement range and a spot cannot be detected due to lack of light quantity.
- The number of detected spots is not less than the Target's label No.

■ Single Measurement Mode

Regardless of the number of detected light spots, only one spot with the specified label number is detected, and the judgment results and measurement results are displayed.

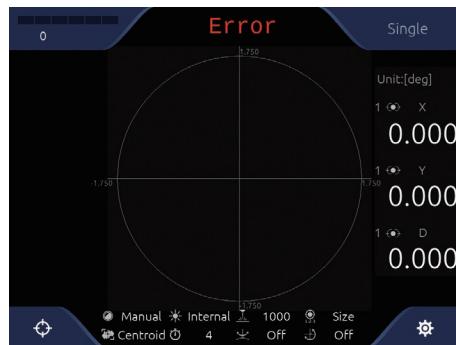

Measurement results display

The result (Absolute value) is shown as below.

- X: Tilting angle from center in X-axis component
- Y: Tilting angle from center in Y-axis component
- D: Tilting angle from center

Measurement results display

When the judgment area (Tolerance) is [On], the judgment results are also displayed.

<Display example of measurement results>

When the judgment area is set like the red frame, inside/outside area judgment result(OK/NG) is displayed as follows.

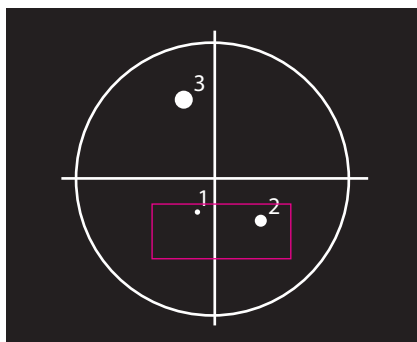

Target: Spot-1→OK
Target: Spot-2→OK
Target: Spot-3→NG

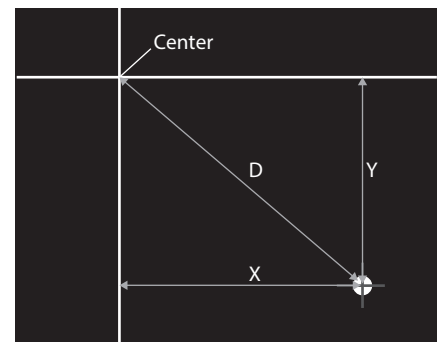

Multi Relative Measurement Mode

Multiple spots (5 spots at maximum) are detected, and judgment results and measurement results are displayed.

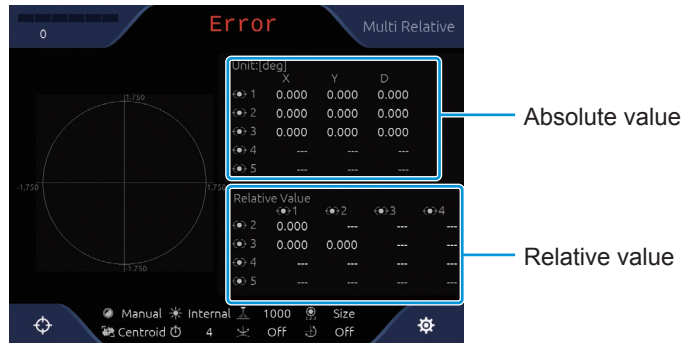

Measurement results display

The measurement result (Absolute and relative values) are shown.

Measurement results (absolute value)

- X: Tilting angle from center in X-axis component
- Y: Tilting angle from center in Y-axis component
- D: Tilting angle from center

Measurement results (relative value)

- Internal angle between each spot.

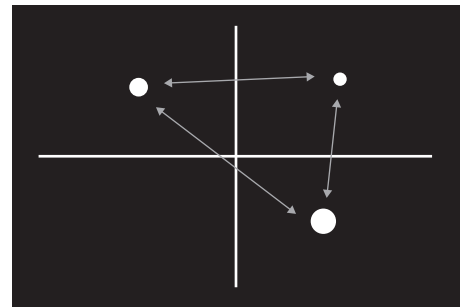

Measurement results display

When the judgment area (Tolerance) is [On], the judgment results are also displayed.

<Display example of measurement results>

In multi-spot measurement mode, 4 measurement light points are specified, and the judgment area is set as shown in the red frame. The light spot judgment result(OK/NG) is displayed as follows.

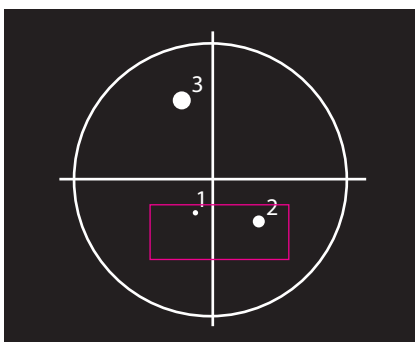

Target: Spot-1→OK

Target: Spot-2→OK

Target: Spot-3→NG

Target: Spot-4→Error

Target: All→NG

Since label No.3 is NG, then the judgment of All become NG.

Also, Target-4 was not measured, so it was excluded from the judgement.

3 Measuring

■ Multi Absolute Measurement Mode

Multiple spots (5 spots at maximum) are detected, and judgment results and measurement results are displayed.

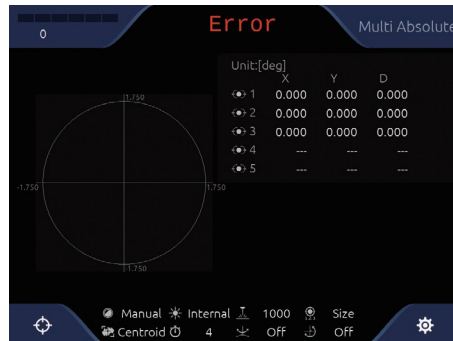

Measurement results display

The result (absolute value) is shown as the angle between center point to each spot.

- X: Tilting angle from center in X-axis component
- Y: Tilting angle from center in Y-axis component
- D: Tilting angle from center

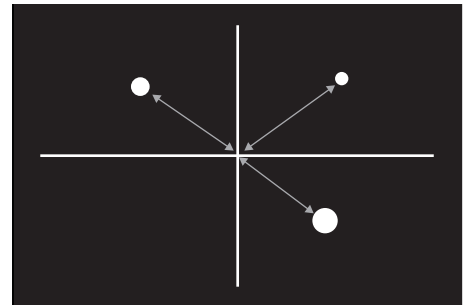

Measurement results display

When the judgment area (Tolerance) is [On], the judgment results are also displayed.

<Display example of measurement results>

In multi-spot measurement mode, 4 measurement light points are specified, and the judgment area is set as shown in the red frame. The light spot judgment result(OK/NG) is displayed as follows.

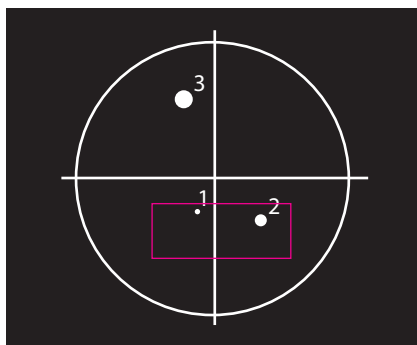

Target: Spot-1→OK
Target: Spot-2→OK
Target: Spot-3→NG
Target: Spot-4→Error
Target: All→NG

Since label No.3 is NG, then the judgment of All become NG.
Also, Target-4 was not measured, so it was excluded from the judgement.

■ Offset Tilt Measurement Mode

In the case of external control, judgment can be made by changing the judgment criteria. Different values can be set for each judgment, and judgment can be made under various conditions by using different range and origin offset.

Judgment criteria can be changed by entering ZeroSet from a command.

The measurement method is Single, and measurement data is sent continuously in Single format.

D1/D2/X-Y and the judgment range label are displayed on the upper left of the monitor during Offset Tilt measurement.

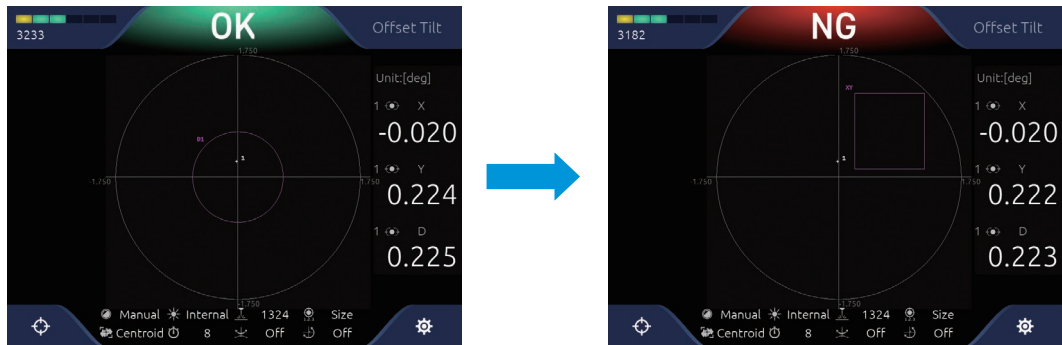

4

Angle Calibration

This section describes the angle calibration procedure. Perform angular calibration when changing the autocollimator or when angle adjustment is required.

To perform angle calibration, a parallel mirror (HS-0) to be the horizontal standard and a wedge substrate (made by Suruga Seiki or equivalent product available commercially) to be the standard angle are necessary.

Overview of Angle Calibration	4-2
Angle Calibration.....	4-3

4 Angle Calibration

Overview of Angle Calibration

Angle calibration is an operation to find the angle displacement (pixel resolution) per one pixel of the CMOS sensor built in the autocollimator.

To perform calibration, install a parallel mirror (HS-0) to be the horizontal standard and the standard substrate of a wedge substrate (made by Suruga Seiki or equivalent product available commercially) to be the standard angle as shown below.

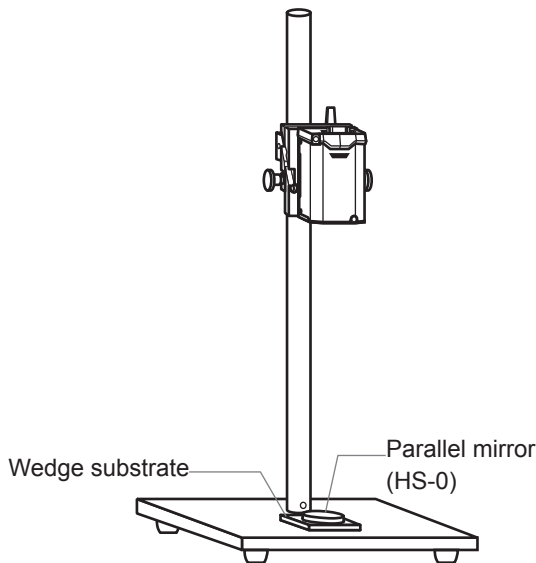

Guarantee condition of linearity performance ($\pm 2\%$ F.S.)

- F.S.= $\pm 1.75^\circ$: Measurement distance < 120 mm
- F.S.= $\pm 1.00^\circ$: Measurement distance < 200 mm
- F.S.= $\pm 0.50^\circ$: Measurement distance < 300 mm

According to the Calibration Wizard displayed on the screen, angle calibration is performed.

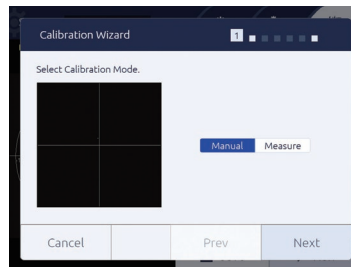

The correction value of angle calibration is calculated according to the following formula.

$$\frac{\text{Wedge substrate angle (deg)}}{\text{Light spot - measurement range center (pixel)}} = \text{Angle per pixel (deg/pixel)}$$

■ Wedge Substrate and Wedge Mirror that can be Used (made by Suruga Seiki)

● Wedge substrate

Model No.	Angle
HS-010	0.10 degrees
HS-020	0.20 degrees
HS-025	0.25 degrees
HS-050	0.50 degrees
HS-100	1.00 degrees
HS-175	1.75 degrees

● Wedge mirror

Model No.	Angle
HS-010AL	0.10 degrees
HS-020AL	0.20 degrees
HS-025AL	0.25 degrees
HS-050AL	0.50 degrees
HS-100AL	1.00 degrees
HS-175AL	1.75 degrees

Angle Calibration

In this section, the angle calibration procedure is explained.

Prepare a parallel mirror (HS-0) to be the horizontal standard and a wedge substrate (made by Suruga Seiki or equivalent product available commercially) to be the standard angle beforehand.

NOTE

- Set the distance from the laser emission port of the autocollimator to the parallel mirror on the target object measurement distance shown in the catalog.
- When a wedge substrate is used, place a parallel mirror on the wedge substrate, and adjust by verifying the light spot is one. When a wedge mirror is used, it can be used as it is.

1 Touch (Settings) in the measurement screen.

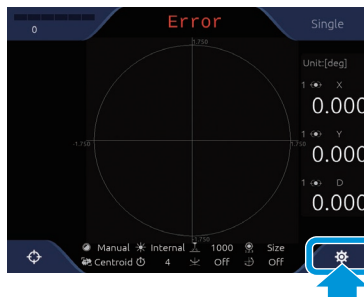

The [Settings] screen is displayed.

2 In the [Settings] screen, touch the (System) tab button.

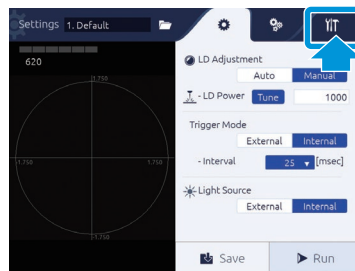

The system settings are displayed.

3 In [Calibration Profile], touch [Custom].

When the settings are not changed, select [Factory].

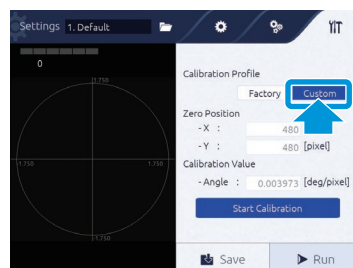

4 Angle Calibration

4 Touch the [Start Calibration] button.

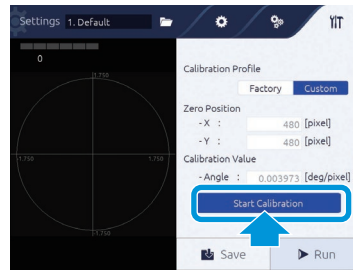

[Calibration Wizard] is displayed.

5 Select a calibration method, and touch the [Next] button.

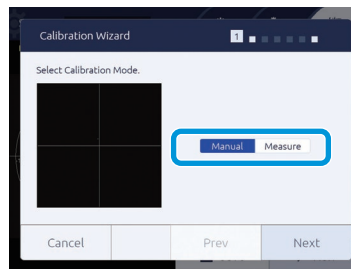

[Manual]: Select when there are value information of calibration values, and entering values directly. Go to Page 4-4: "Manual is selected".

[Measure]: Select when calibration is done by measuring a wedge mirror that wedge angle is already known. Go to Page 4-5: "Measure is selected".

● Manual is selected

6 Select a calibration value, and touch the [Next] button.

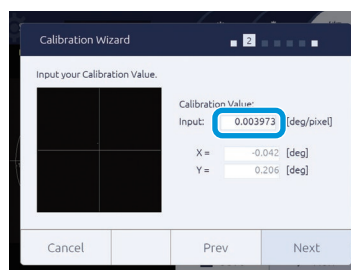

7 Check the content, and touch the [OK] button.

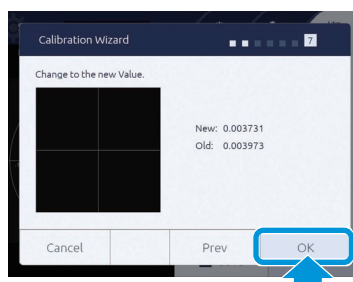

The confirmation dialog is displayed.

8 Touch the [OK] button.

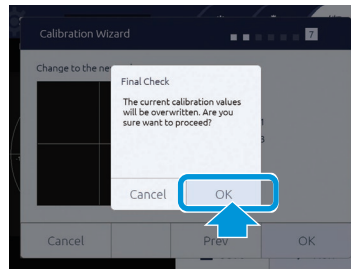

The angle calibration value is applied.
When [Cancel] is touched, it ends without calibration.

● Measure is selected

6 Set a parallel mirror, and touch the [Next] button.

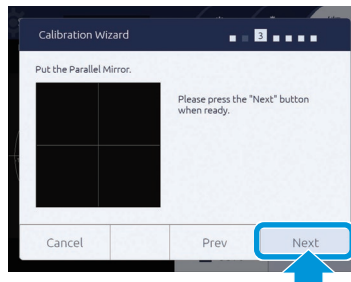

7 Set the measurement center, and touch the [Next] button.

Adjust to match the light spot to the displayed center line, and touch [ZeroSet] to set the measurement center.
Enter a threshold to [Binarization Threshold].

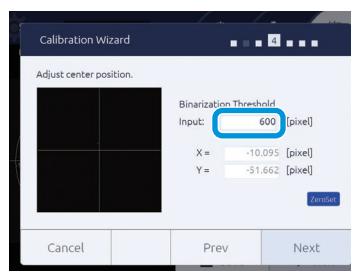

4 Angle Calibration

8 Set a wedge substrate, and touch the [Next] button.

Set a wedge substrate on the reference surface and a parallel mirror on the wedge substrate.

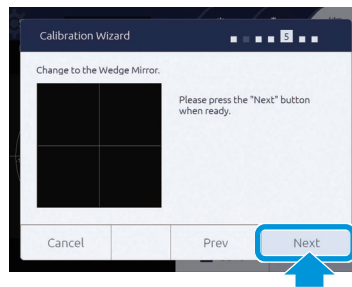

Info

Instead of the wedge substrate and parallel mirror, a wedge mirror can be used.

9 Enter a wedge substrate angle, and touch the [Next] button.

By entering the wedge substrate angle in [Input], the calibration value is calculated.

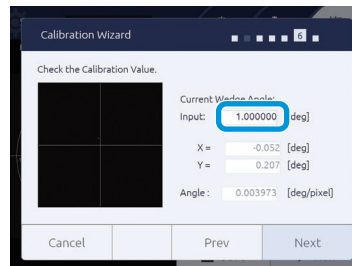

10 Check the content, and touch the [OK] button.

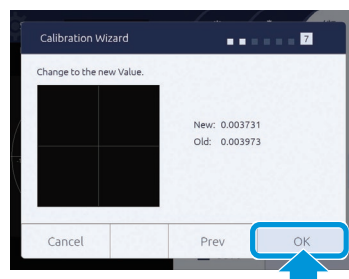

The confirmation dialog is displayed.

11 Touch the [OK] button.

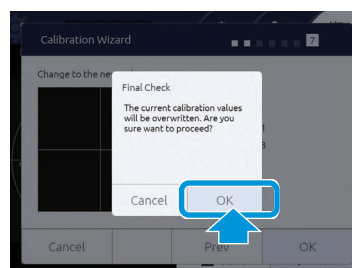

The angle calibration value is applied.

When [Cancel] is touched, it ends without calibration.

5

Control from External Devices

This product can be operated with commands from external devices by using serial communication (RS232C) and Ethernet communication.

In this section, commands and various settings used in communication with external devices are explained.

Connection Specifications with External Devices ...	5-2
Setting the PC Network and IPU (Image Processing Unit) IP Address ...	5-4
Setting the FTP	5-9
Operating the Setup Transfer Tool.....	5-22
Data Communication Format	5-30
Device Control with External Commands	5-31

5 Control from External Devices

Connection Specifications with External Devices

This product connects with external devices via serial connection (RS232C) or Ethernet connection.

■ Connection with RS232C

Connection specifications of RS232C are explained.

Command sending is performed by using communication application. The port to connect is checked through system information of PC.

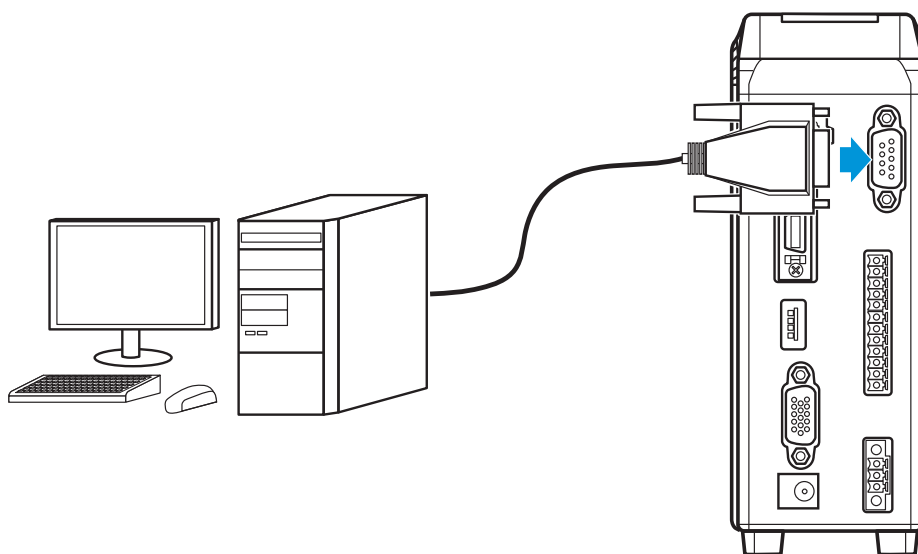

Communication conditions

Item	Content
Baud rate	9600/19200/38400/57600/115200 bps
Data length	8 bit
Parity	Non
Stop bit length	1 bit
Flow control	Non

RS232C connector pin assignment

Use D-sub 9-pin cross cable for the RS232C cable to connect with external devices.
7-pin and 8-pin are short circuit inside the main body.

Pin No.	Signal name	Remarks
1		
2	RxD	Receiving data
3	TxD	Sending data
4		
5	GND	
6		
7	RTS	Send request
8	CTS	Send permission
9		

■ Connection with Ethernet

Connection specifications of Ethernet are explained.

Command sending is performed by using communication application. IP address and port number to connect is set with the system settings (→ Page 2-28).

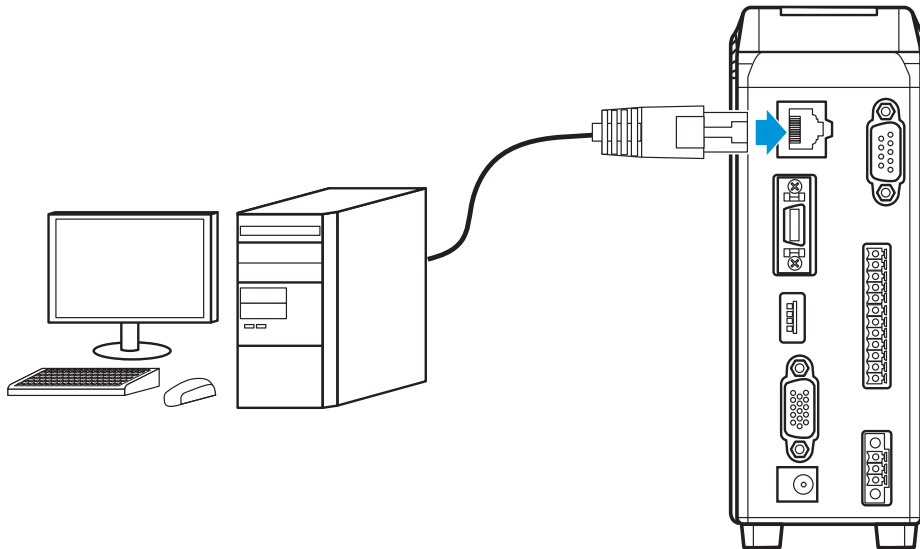

Communication items

- Output of measurement results (Data Output port)
- Control command and input/output of response (Command port)
- Raw image data output used for measurement (FTP)

Info

In Data Output Port, a number (Command Port + 1) is automatically set.

Communication specifications

- 1000base-T and 100Base-TX^{*1}
- TCP/IP socket communication
- FTP communication

^{*1} At image data output, 1000Base-T is required.

5 Control from External Devices

Setting the PC Network and IPU (Image Processing Unit) IP Address

This section covers the basic setting procedure for connection of the H410 model with a PC.

■ Setting the PC Network IP Address

This section covers the basic setting procedure for the PC network IP address.
The supported PC operating system is Windows10.

- 1 Connect the PC and IPU with the Ethernet cable.
- 2 Connect the IPU and touch panel monitor with the monitor cable.
- 3 Start up the PC.
- 4 Open the Control Panel and click [Network and Sharing Center].

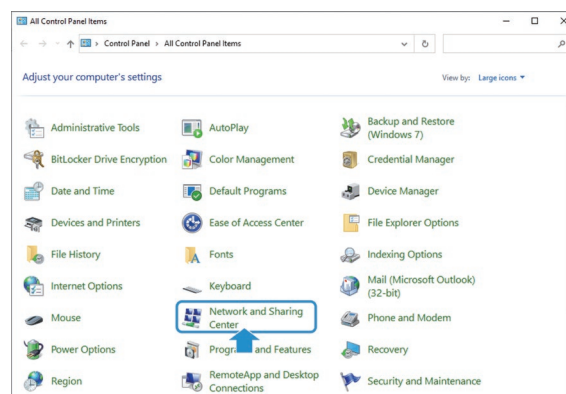

The screens displayed will be [Control Panel] > [All Control Panel Items] > [Network and Sharing Center].

- 5 Click [Ethernet].

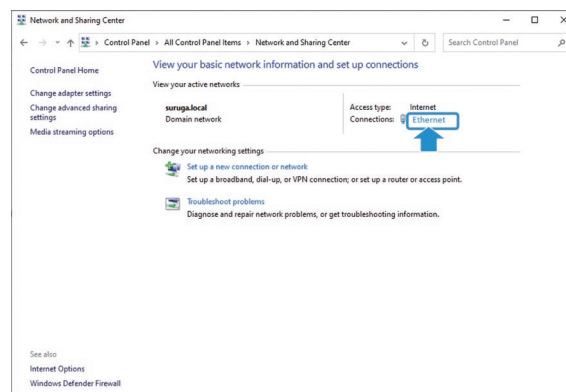

The [Ethernet Status] screen is displayed.

6 Click [Properties].

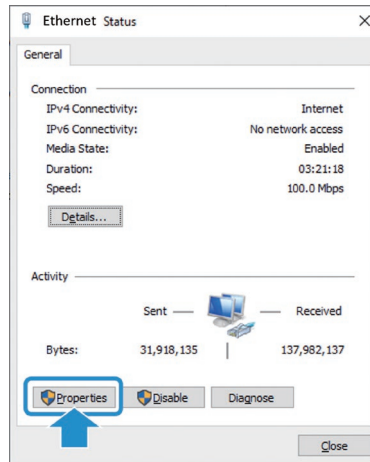

The [Ethernet Properties] screen is displayed.

7 Check the [Internet Protocol Version 4 (TCP/IPv4)] box and click the [Properties (R)] button.

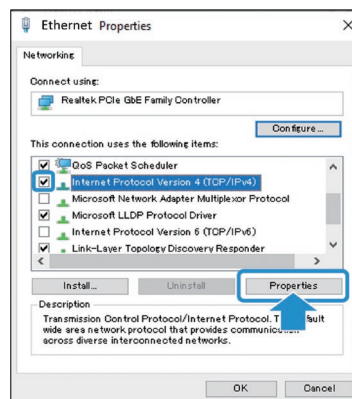

The [Ethernet Protocol Version 4 (TCP/Pv4)] screen is displayed.

8 Check the [Use the following IP address (S)] box.

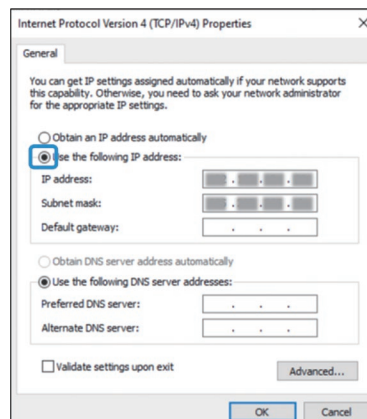

5 Control from External Devices

- 9 With reference to the [IP address (I)], [Subnet mask (U)], and [Default gateway (D)] examples, input the setting information.

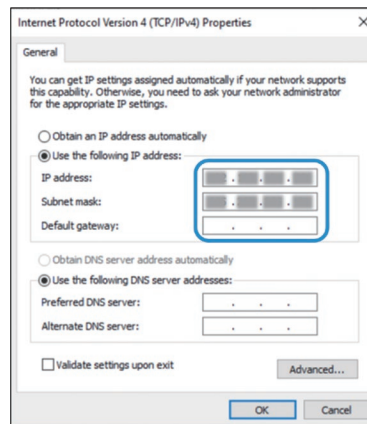

Setting examples

IP address (I): 192.168.0.99

Subnet mask (U): 255.255.255.0

Default gateway (D): Blank

NOTE

For the IP address, we recommend avoiding the use of the IPU default value (192.168.0.100). When the IPU IP address has been changed from the default value, (192.168.0.100) can be set.

- 10 Check the [Use the following DNS server address (E)] box and click [OK].

NOTE

Input is not required for [Preferred DNS server (P)] or [Alternate DNS server (A)].

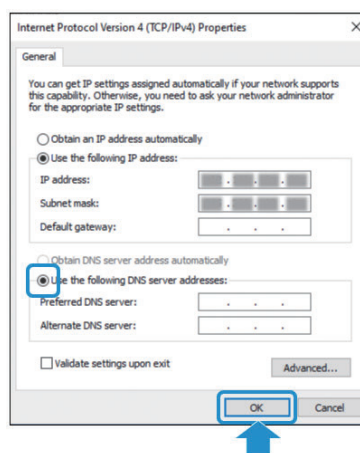

The IP address is set.

Click [Cancel] to cancel the IP address setting.

■ H410 Model System Setting

This section covers the basic setting procedure for the H410 model system.

- 1 Start up the H410 model.
- 2 Touch  [Settings] on the measurement screen.

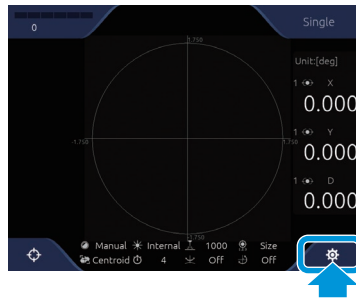

The [Settings] screen is displayed.

- 3 On the [Settings] screen, touch the  [System] tab.

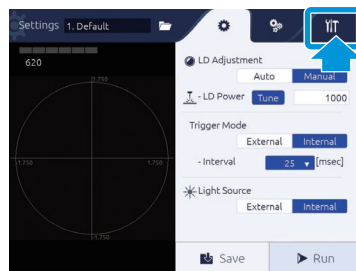

The system settings are displayed.

5 Control from External Devices

4 Input the settings with reference to the [Ethernet] [IP address], [Subnet mask] and [Default gateway] examples.

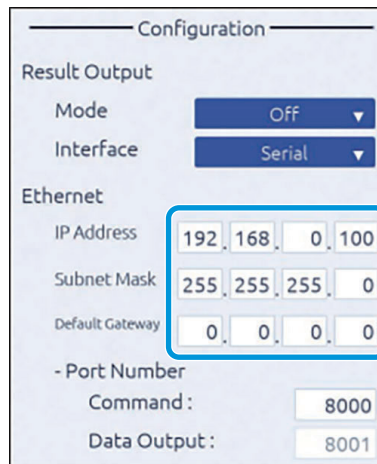

The screenshot shows a 'Configuration' window with the following settings:

- Result Output Mode: Off
- Interface: Serial
- Ethernet IP Address: 192.168.0.100
- Ethernet Subnet Mask: 255.255.255.0
- Ethernet Default Gateway: 0.0.0.0
- Port Number Command: 8000
- Data Output: 8001

The IP Address, Subnet Mask, and Default Gateway fields are highlighted with a blue box.

Setting examples

IP address: 192.168.0.100

Subnet mask: 255.255.255.0

Default gateway: 0.0.0.0

NOTE

The IP address can be set anywhere in the range of 192.168.0.xxx (xxx = 1 to 254) as long as it does not overlap with the IP address (ex.: 192.168.0.99) set in "■Setting the PC Network IP Address" step 11 (→ Page 5-4).

5 When input is complete, touch the [Save] button.

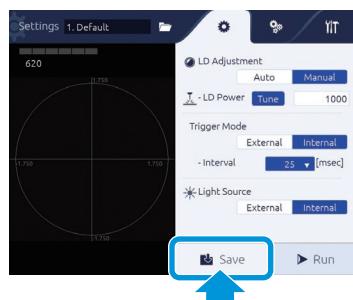

The IP address setting is saved.

Setting the FTP

■ Enabling the FTP Server Function

This section covers the basic procedure for enabling the FTP server function.

1 Open the Control Panel and click [Programs and Features].

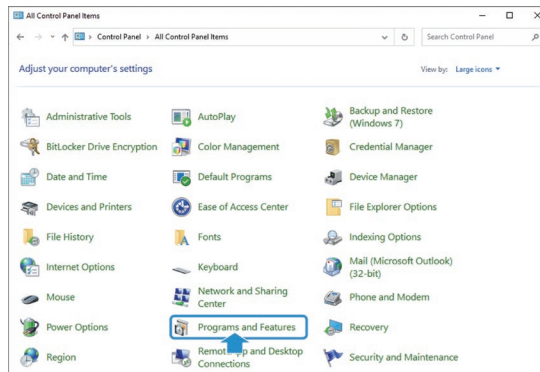

The screens displayed will be [Control Panel] > [All Control Panel Items] > [Programs and Features].

2 Click [Turn Windows features on or off].

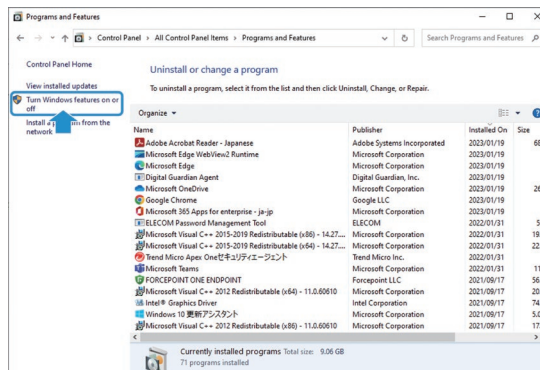

The [Windows Features] screen is displayed.

3 Go through in the order of [Internet Information Services] > [FTP Server] and [Web Management Tools] > [IIS Management Console], check the box, and click the [OK] button.

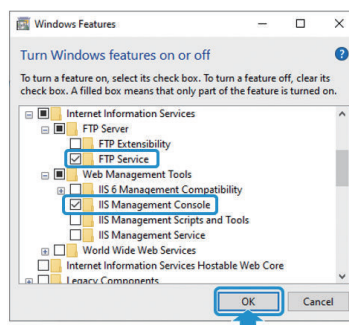

Click the [Cancel] button to cancel the enabling process.

5 Control from External Devices

■ Creating a User

This section covers the basic procedure for creating a user to connect to the FTP server.

1 Open the Control Panel and click [Administrative Tools].

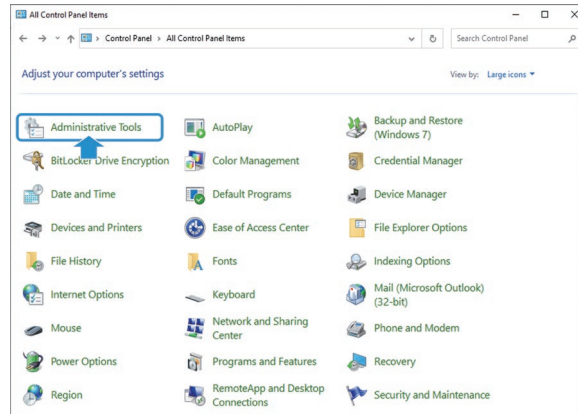

The screens displayed will be [Control Panel] > [All Control Panel Items] > [Administrative Tools].

2 Double-click [Computer Management].

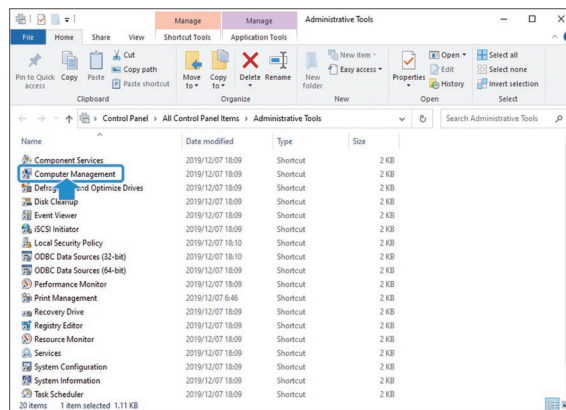

The [Computer Management] screen is displayed.

3 Double-click [Local Users and Groups].

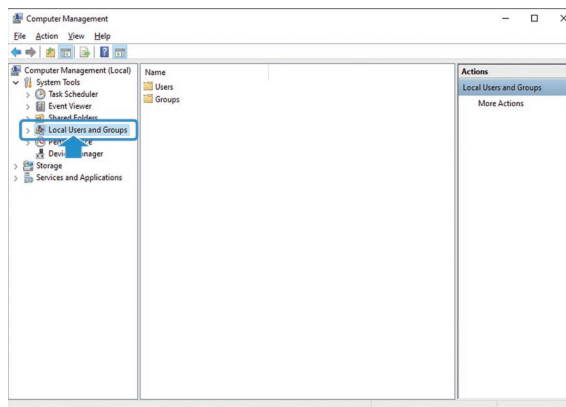

4 Right-click [Users].

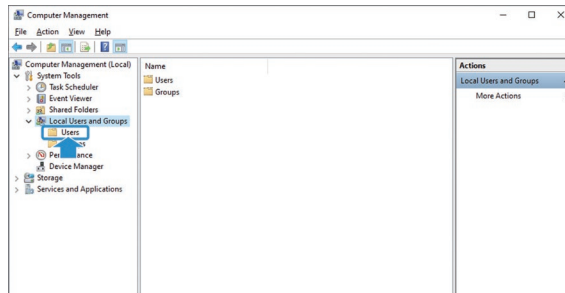

5 Click [New User].

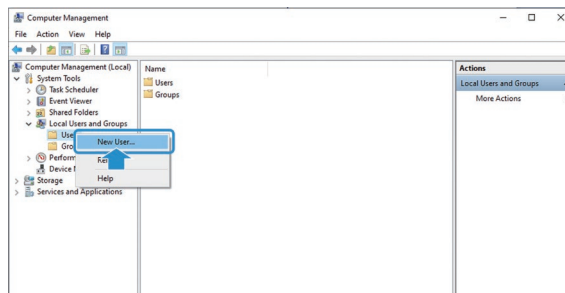

6 Input the user name and password.

The user name and password may be chosen at will.

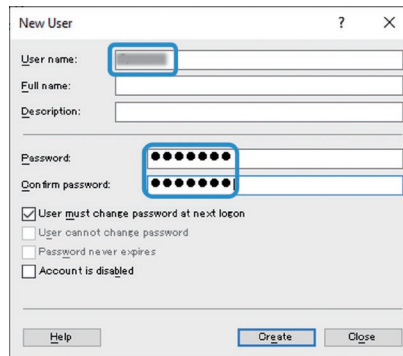

7 Uncheck [User must change password at next logon (M)], check [Password never expires (W)], and click the [Create] button.

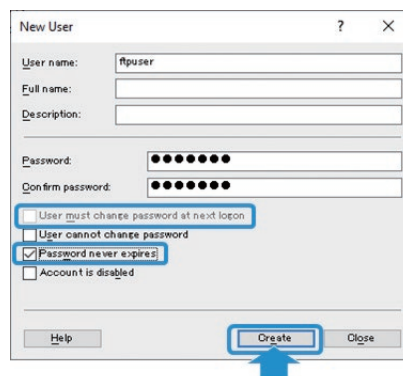

Click the [Close] button to cancel the user creation process.

5 Control from External Devices

8 Double-click [Users] and confirm that the previously created user has been registered.

■ Setting the FTP Server

This section covers the basic setting procedure for the FTP server.

1 Open the Control Panel and click [Administrative Tools].

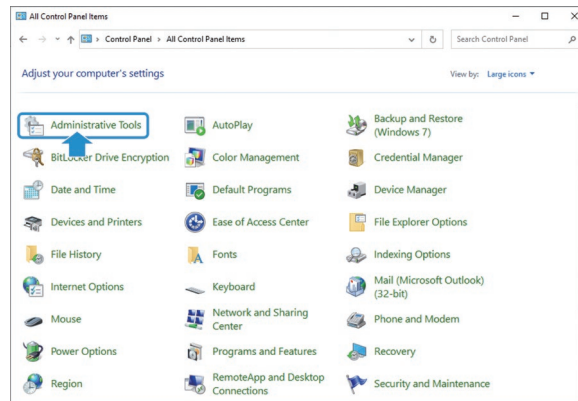

The screens displayed will be [Control Panel] > [All Control Panel Items] > [Administrative Tools].

2 Double-click [Internet Information Services (IIS) Manager].

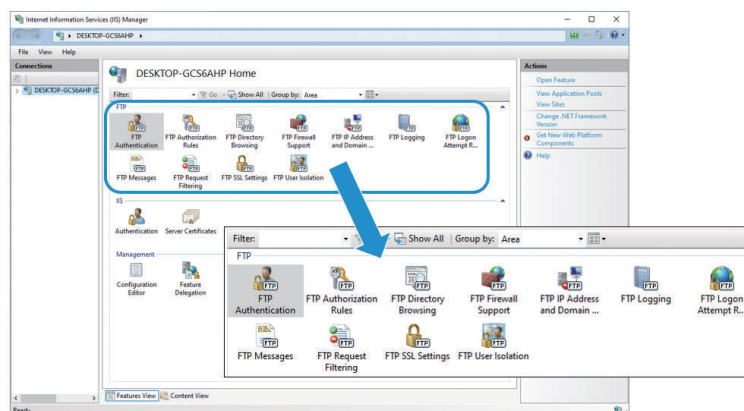
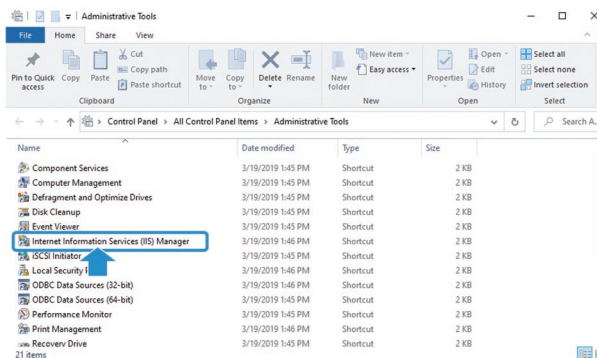

When FTP service is installed, the Features view in the middle of the [Internet Information Services (IIS) Manager] screen will display the FTP function icon.

5 Control from External Devices

3 Right-click the server icon on the left panel and click [Add FTP site].

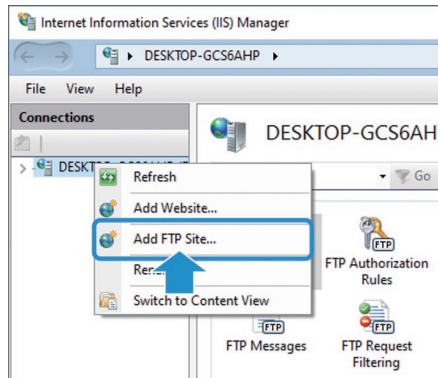

The [Site Information] setting screen is displayed.

4 Input a name into [FTP site name (E)], select [Physical path (H)], and click the [Next] button.

[FTP site name (E)] may be chosen at will.

For [Physical path (H)], create an FTP file directly under C: in advance and select it here.

Ex.: C:\inetpub\ftproot

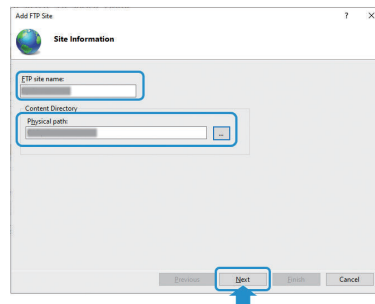

The [Binding and SSL Settings] setting screen is displayed.

Click the [Cancel] button to cancel the FTP server setting.

5 Under [SSL], check the [No SSL] box and click the [Next] button.

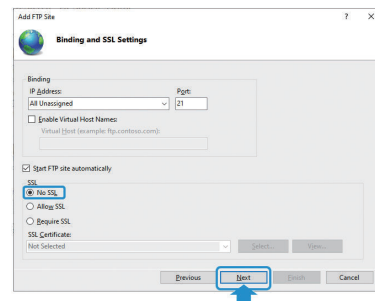

The [Authentication and Authorization Information] setting screen is displayed.

Click the [Cancel] button to cancel the FTP server setting.

5 Control from External Devices

6 For [Authentication], check the [Basic (B)] box.

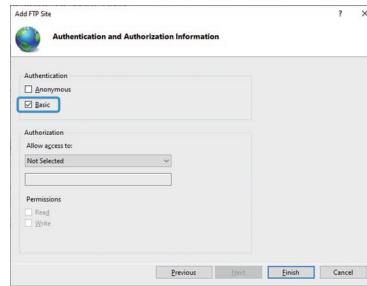

7 For [Allow access to <1088>(C)], select [Specified roles or user groups] and input the user name created in 6 on Page 5-11.

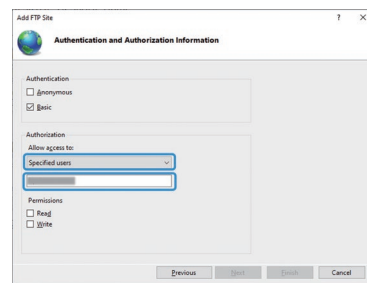

8 For [Permissions], check the [Read] and [Write] boxes and click the [Finish] button.

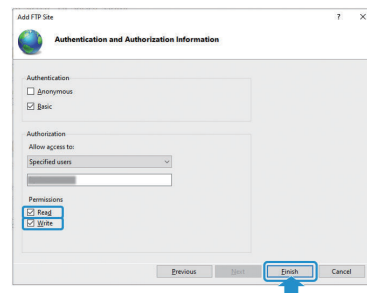

Click the [Cancel] button to cancel the FTP server setting.

9 Right-click the FTP site and click [Add Virtual Directory].

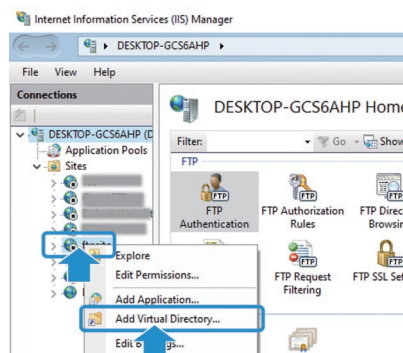

The [Add Virtual Directory] screen is displayed.

5 Control from External Devices

10 Input the name classifying the Web server into [Alias (A)], input the Web server physical path into [Physical path (P)], and click the [OK] button.

For [Physical path (P)], create a file directly under C: in advance and select it here.

Ex.: [Alias (A)]: wwwroot

[Physical path (P)]: C:\inetpub\wwwroot

When setting "Upload Folder (FTP)" in the IPU system setting, the content set with this item will be required.

Setting [Alias (A)] enables the IPU to upload image data to the folder set with the physical path.

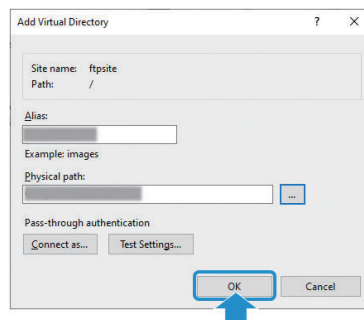

Click the [Cancel] button to cancel the "Add virtual directory" process.

11 Click the FTP site and then double-click [FTP Directory Browsing] in the center of the list of functions.

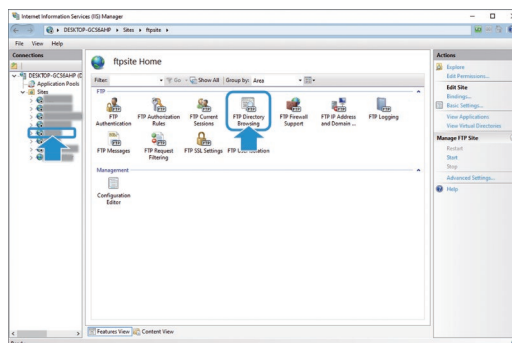

The [FTP Directory Browsing] screen is displayed.

12 Check the [Virtual directories] box under [Directory Listing Options].

A list of virtual directories is displayed with the FTP client, enabling confirmation of the setting content.

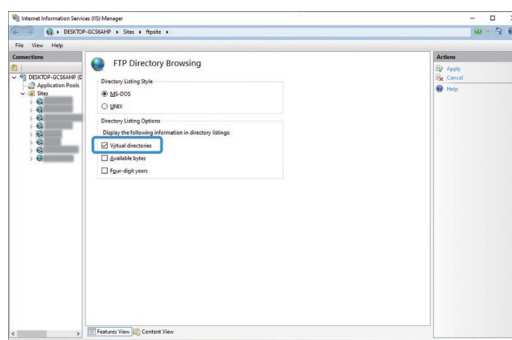

5 Control from External Devices

■ Permitting Communication Through the Firewall

This section covers the basic setting procedure for the firewall.

1 Open the Control Panel and click [Security and Maintenance].

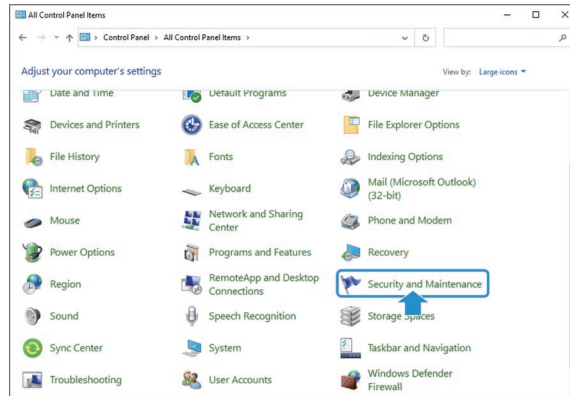

The screens displayed will be [Control Panel] > [All Control Panel Items] > [Security and Maintenance].

2 Click [Security (S)].

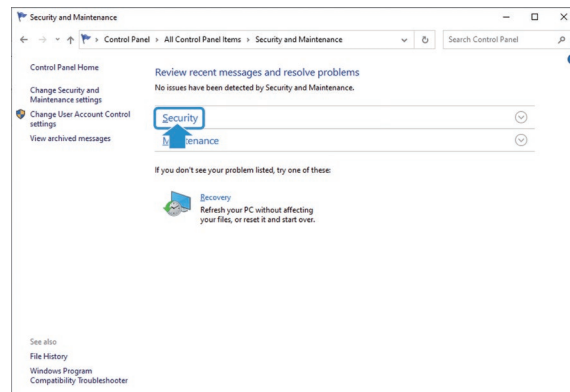

3 Click through as follows: [Security (S)] > [Network Firewall] > [Display Windows Security].

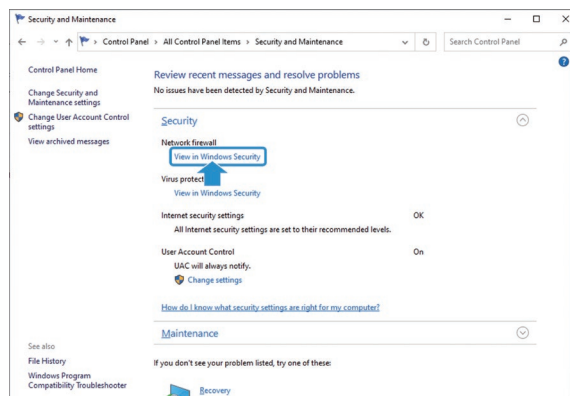

The [Windows Security] screen is displayed.

5 Control from External Devices

4 Click [Allow an app through firewall].

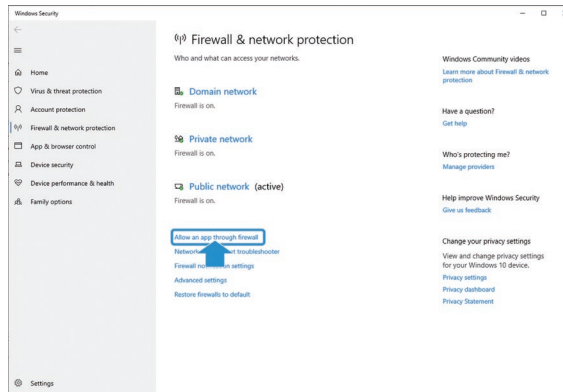

The screens displayed will be [Control Panel] > [All Control Panel Items] > [Windows Defender Firewall] > [Allowed apps].

5 Click the [Change settings] button.

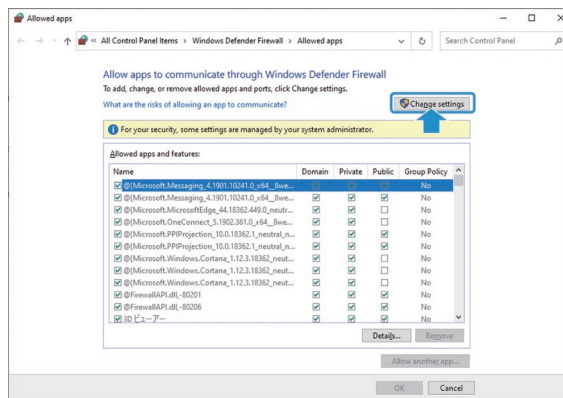

6 Check the [Private] and [Public] boxes under [FTP Server] and click the [OK] button.

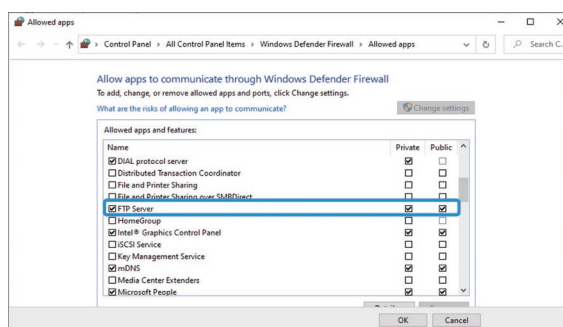

Click the [Cancel] button to cancel the communication through firewall setting.

5 Control from External Devices

Starting the FTP Server

This section covers the basic startup procedure for the FTP server.

1 Open the Control Panel and click [Administrative Tools].

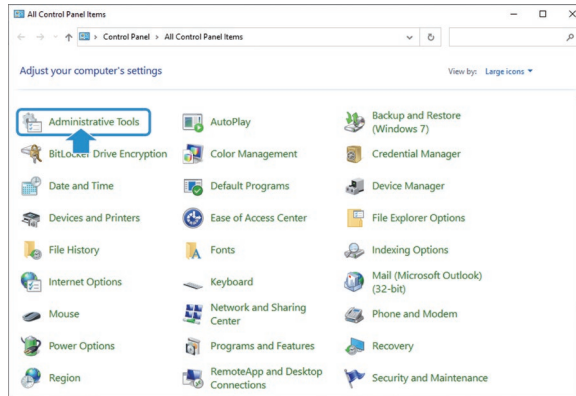

The screens displayed will be [Control Panel] > [All Control Panel Items] > [Administrative Tools].

2 Double-click [Computer Management].

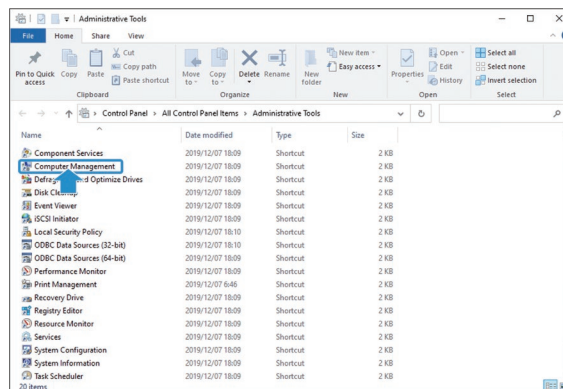

The [Computer Management] screen is displayed.

3 Click [Services and Applications].

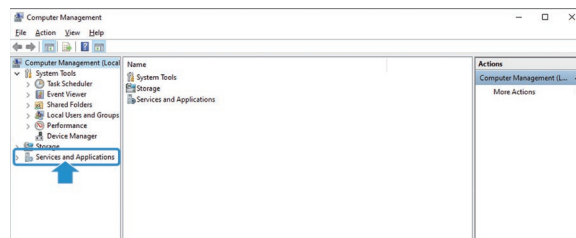

4 Click [Internet Information Services (IIS) Manager].

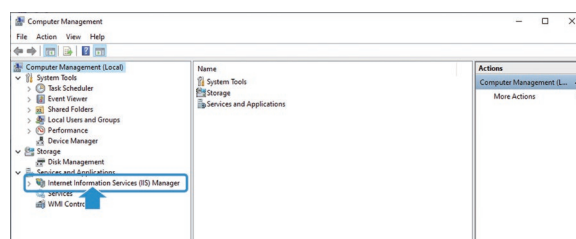

5 Double-click [Connect] for the FTP site.

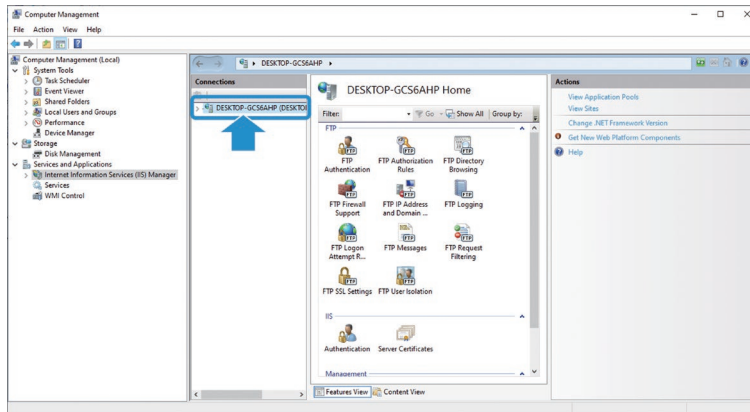

6 Click [Sites].

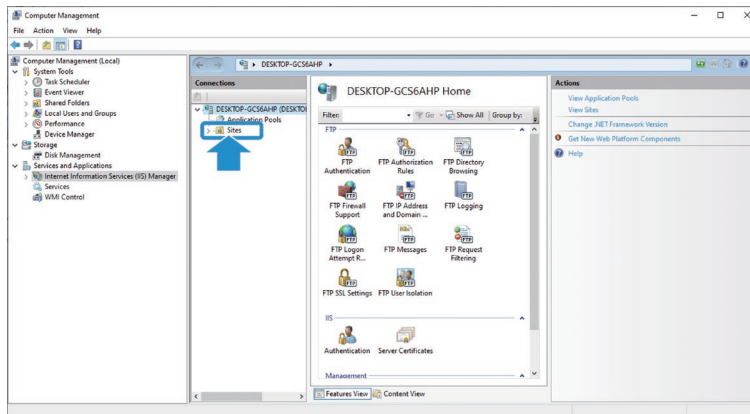

7 Right-click the registered site.

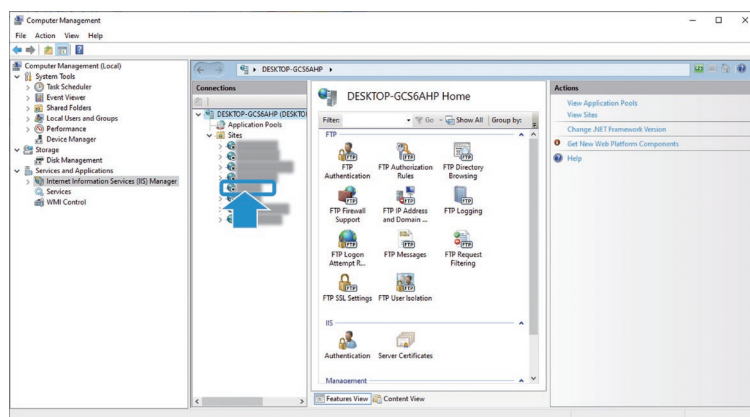

5 Control from External Devices

8 Click [FTP Site Management] and then [Start].

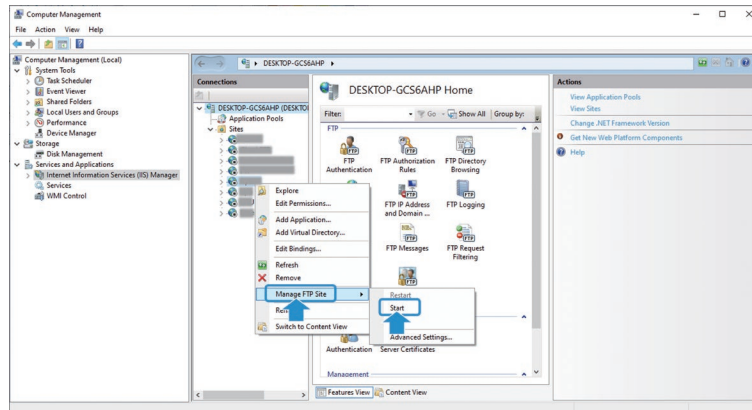

The FTP site will start up.

■ Setting an IP Address Connecting to the FTP Server

This section covers the basic setting procedure for IP addresses connecting to the FTP server.

1 To set an IP address connecting to the FTP server, see the section on "■Setting the PC Network IP Address" (→Page 5-4).

■ Setting the IPU FTP

A screenshot of the 'Image Output (FTP)' configuration window. It features a toggle switch for 'Image Output (FTP)' set to 'Off'. Below the toggle are four input fields: 'IP Address' with the value '192.168.0.2', 'User Name' with 'ss_ipu', 'Password' with '1234', and 'Upload Folder' with '/ftp'.

Image Output (FTP)

Input the IP address set in IP Address: pages 5-6, 9.

User Name: User name set with pages 5-11, 6

Password: Password set with pages 5-11, 6

Upload Folder: Alias set with pages 5-15, 10

FTP construction is now complete.

Turn Image Output (FTP) ON to save all image data to the Upload Folder during normal measurement. As image data will continue to be saved until Image Output (FTP) is turned OFF, make sure the PC's storage capacity is not overwhelmed.

■ Supplementary Items

- 1) If connection with the FTP server is not possible even after completing FTP setting, do as follows.
[Turn off firewall]

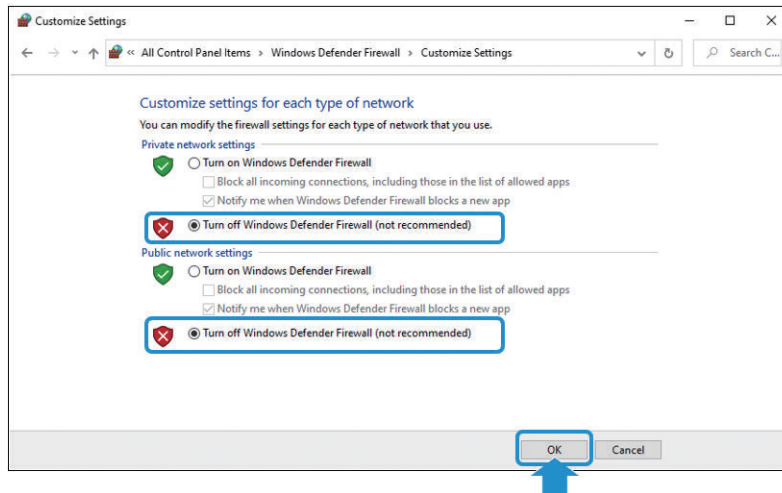

In the order of [Control Panel] > [Systems and Security] > [Windows Defender Firewall], select [Turn off Windows firewall] under both [Private networks] and [Public networks] and click the [OK] button.

- 2) When the FTP cannot be normally connected, the screen may freeze for several minutes.

5 Control from External Devices

Operating the Setup Transfer Tool

This section covers the basic operation of the Setup Transfer Tool.

■ Starting the Setup Transfer Tool

This section covers the basic startup procedure of the Setup Transfer Tool.

NOTE

The Setup Transfer Tool cannot be used during measurement with the H410 model. Switch to the setting screen before use.

1 Unzip [SetupTransferTool_Ver.xxx.zip].



A [SetupTransferTool_Ver.xxx] folder is created.

2 Double-click the [SetupTransferTool_Ver.xxx] folder.

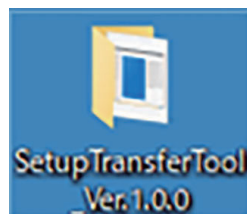

The [SetupTransferTool_Ver.xxx] folder opens.

3 Double-click [Release_Ver.xxx].

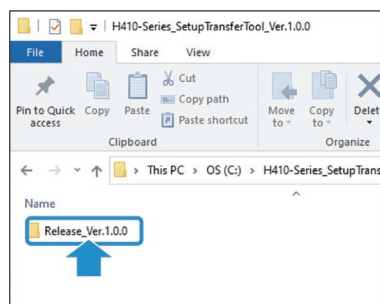

The [Release_Ver.xxx] folder opens.

4 Double-click [SettingTool.exe].

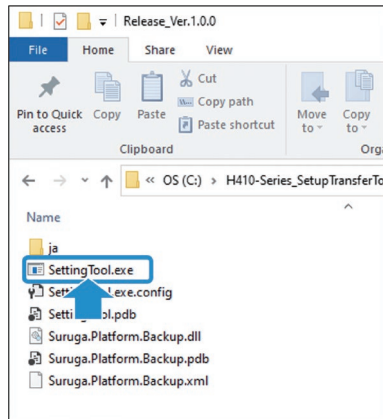

The [Setup Transfer Tool] window opens.

■ Understanding the [Setup Transfer Tool] Window

This section covers how to understand the [Setup Transfer Tool] window.

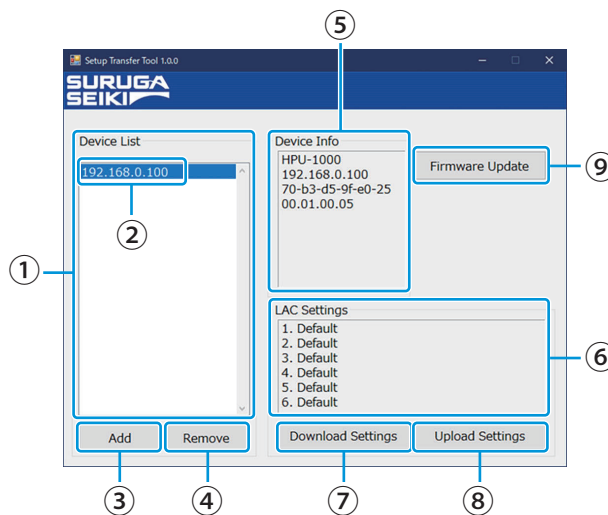

① Device list

Displays a list of each device's IP address.

② IP address

Displays the IP addresses added in "■ Adding Devices" (→ Page 5-24).

③ [Add] button

Touch to add IP addresses. (→ Page 5-24)

④ [Remove] button

Touch to remove added IP addresses. (→ Page 5-25)

⑤ Device info

Displays information about the selected device.

5 Control from External Devices

⑥ LAC settings

Displays the name of the [setting files] on the H410 model.

⑦ [Download Settings] button

When clicked, downloads the setting files on the H410 model. (→ Page 5-27)

⑧ [Upload Settings] button

When clicked, uploads setting files to the H410 model. (→ Page 5-27)

⑨ [Firmware Update] button

When clicked, updates the IPU firmware on the H410 model. (→ Page 5-28)

■ Adding Devices

This section covers the basic procedure for adding devices.

1 Click the [Add] button.

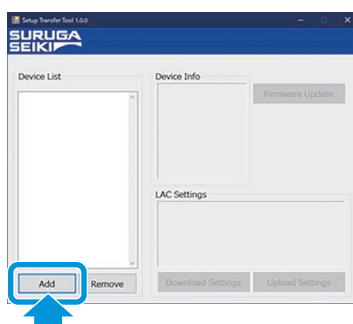

The [Add Network Device] screen is displayed.

2 Input the IP address set in step 4 of "■H410 Model System Setting" and click the [OK] button.

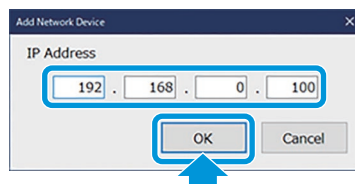

The added IP address is displayed in the [Device List].
Click the [Cancel] button to remove the entered IP address.

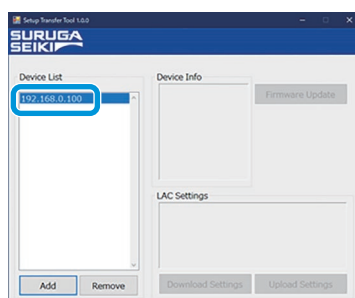

■ Removing Devices

This section covers the basic procedure for removing devices.

- 1 In the Device List, click the IP address to be removed and then click the [Remove] button.

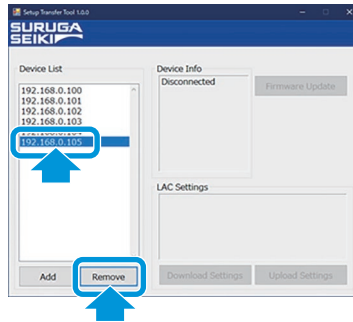

When the [Remove] button is clicked, a confirmation screen is displayed.

- 2 Click the [OK] button.



The IP address is removed from the [Device List].
Click the [Cancel] button to cancel the device removal.

5 Control from External Devices

■ Connecting Devices

This section covers the basic procedure for selecting an IP address for device connection.

1 Click the IP address in the [Device List].

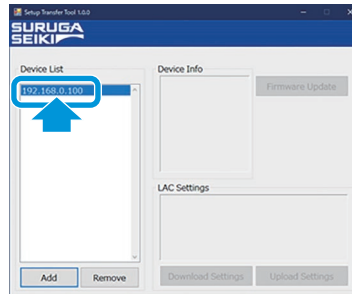

After connection with the device, if communication begins normally, the information in [Device Info] and [LAC Settings] will be updated.

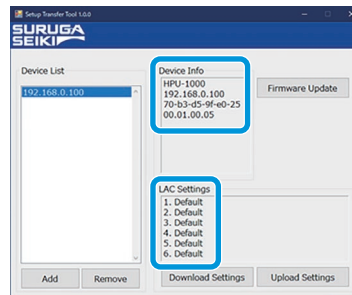

If connection with the device is not possible, the [Disconnected] window will appear in [Device Info].

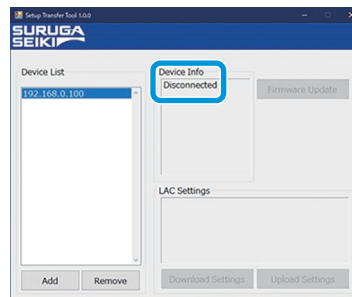

NOTE

When reconnecting devices or updating information in [Device Info] and [LAC Settings], click the IP address in the [Device List] again.

■ Downloading Setting Files

This section covers the basic procedure for downloading setting files set with the H410 model.

- 1 Click the IP address of the device for setting file download, and click the [Download Settings] button.

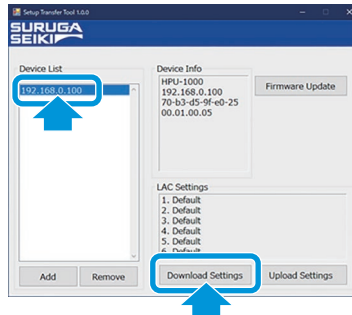

The [Save As] window is displayed.

- 2 Set the file name and click the [Save (S)] button.

When the [Save (S)] button is clicked, the file will be saved with a .lac extension in a folder. The folder will be automatically generated with the connected name in the Device List.

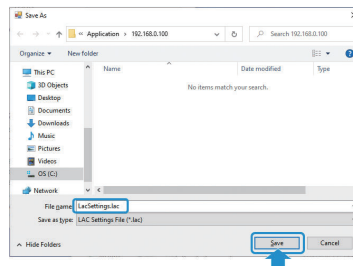

Click the [Cancel] button to cancel the setting file download.

■ Uploading Setting Files

This section covers the basic procedure for uploading setting files to the H410 model.

- 1 Click the IP address of the device for setting file upload, and click the [Upload Settings] button.

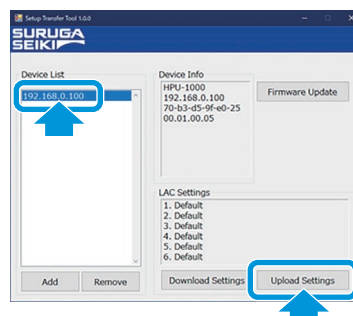

The [Open] window is displayed.

5 Control from External Devices

2 Select a setting file and click the [Open (O)] button.

The setting file extension is .lac.

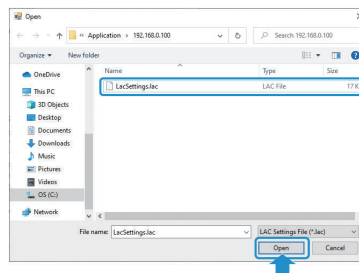

The [Update setup] window is displayed.

Click the [Cancel] button to cancel the setting file upload.

3 Click the [OK] button.

NOTE

To overwrite system settings other than network-related settings (IP address, network, gateway) at the same time, check the box.

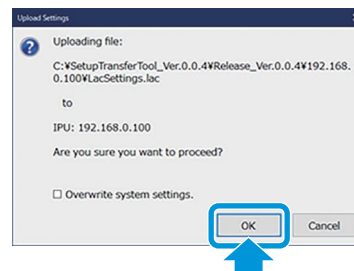

Setting files are uploaded to the H410 model.

Click the [Cancel] button to cancel the setting file upload.

■ Updating Firmware

This section covers the basic procedure for updating the H410 model IPU firmware.

1 Click the [Firmware Update] button.

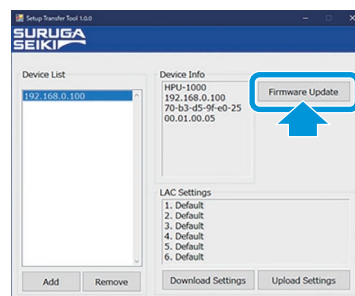

The [Open] window is displayed.

5 Control from External Devices

2 Select firmware and click the [Open (O)] button.

The firmware extension is .dat.

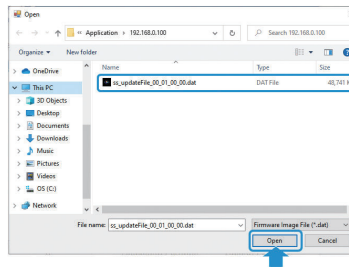

The confirmation screen is displayed.

Click the [Cancel] button to cancel the firmware upload.

3 Click the [OK] button.

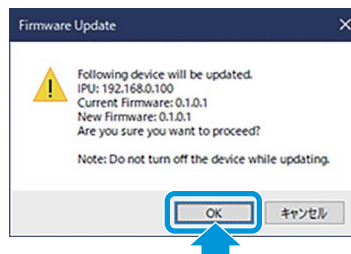

Firmware updating begins and a window calling for a restart is displayed.

10 minutes or so are required for updating.

Click the [Cancel] button to cancel the firmware updates.

4 Click the [OK] button.

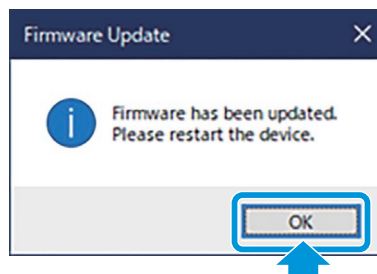

5 Restart the H410 model.

Firmware updating is complete.

5 Control from External Devices

Data Communication Format

For details of formats, see “■Command Format” (Page 5-33”).

In this section, examples of data receiving images by each mode are introduced.

Info

H410 and HIP-1200 mode use same communication format.

● In case of Internal Mode

Judgment results and measurement values are sent to output destination with a specified cycle.

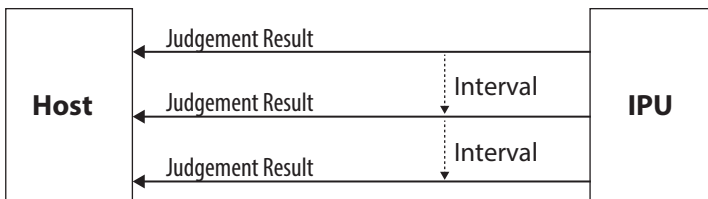

● In case of Trigger Mode

Judgment results and measurement values are sent to output destination, if pulse is input to DI (Measurement start trigger).

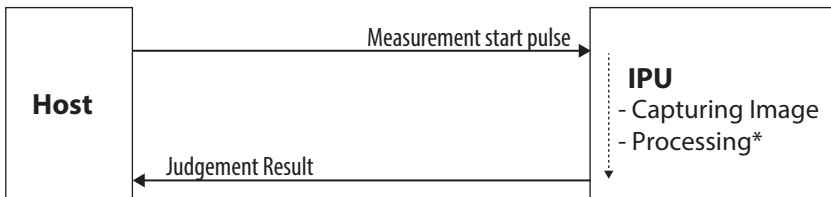

*The process time differs depending on the measurement condition.

■ Measurement Results Output Formats

Each measurement result is output with the following formats. Each character is written with ASCII code.

Info

Output data are output after being stored inside the buffer. When measurement speed is faster than an output speed, BUSY is output until output becomes possible with filled internal buffer.

Example of single measurement data

<Basic Alignment>

G	,	*S	,	*X	,	*Y	,	*D	CR	LF
---	---	----	---	----	---	----	---	----	----	----

G: Header

*S: Judgment result

*X, *Y and *D: Measurement result

- In case of Judgment = OK, Unit = deg, X = +0.123, Y = -0.001 and D = 0.020

G,O,+0.123,-0.001,0.020CRLF

ASCII (hexadecimal notation):

472c4f2c2b302e3132332c2d302e3030312c20302e3032300d0a

- Judgment = In case of NG
G,N,999999,999999,999999CRLF
ASCII (hexadecimal notation):
472c4e2c3939393939392c3939393939392c393939393939d0a

Device Control with External Commands

This product can control with commands from external devices connected by RS232C and Ethernet. In this section, the commands and command formats that can be used are explained.

Info

For default setting of IPU, data output at the maximum frame rate (25 ms) for both Normal Mode/HIP-1200 Mode in RS232C communication and Ethernet communication is supported. However, for data acquisition in command communication, as it depends on the PC environment you are using, a little delay may be occurred. When need to perform stable data reception equivalent to the frame rate, please use the Stream function.

The waiting time between each command should be 200msec or more.

List of External Commands

The external commands that can be used are introduced.

● In case of normal mode (at factory shipping settings)

Identification character	Command content	Process on the IPU side
R000	File readout command	Send the setting values of the specified file
R001	File basic information reading command	Send the basic information of a file
R102	Setting value individual request command	Send the setting values of the specified item
R103	Setting value batch request command	Send the setting values as batch
R109	Measurement value request command	Send measurement results
R111	LD output setting values request command	Send the setting values of LD output
R112	LD output automatic adjustment mode request command	Send the setting values of LD output automatic adjustment mode
R113	LD external output mode request command	Send the setting values of LD external output
R114	External trigger mode request command	Send the setting values of external trigger mode
R115	Camera internal trigger interval time request command	Send the setting values of internal trigger mode
R116	Camera exposure time request command	Send the setting values of exposure time
R119	Measurement luminance readout command	Send a luminance value
R120	Display setting request command	Send the setting values of display settings
R121	Zoom setting request command	Send the setting values of Zoom settings
R122	Measurement value output setting request command	Send the setting values of measurement output settings
R123	GPIO Strobe setting request command	Send the setting values of DIO Strobe settings
R124	Binary threshold for pixel calibration request command	Send a binary threshold used for calibration
R125	Pixel calibration mode request command	Send the setting values of calibration mode
R126	Pixel calibration value for user settings request command	Send the pixel calibration value when the calibration mode is the user settings

5 Control from External Devices

Identification character	Command content	Process on the IPU side
R127	Zero calibration value mode request command	Send the setting values of zero calibration value mode
R128	Zero calibration value for user settings request command	Send zero calibration value for user settings
R129	RAW image output mode request command	Send the setting values of RAW image output mode
R130	LD output automatic adjustment result request command	Send the results of LD output automatic adjustment
R080	System information readout command	Send system information
R081	RS232C setting request command	Send the setting values of RS232C settings
R082	Ethernet setting request command	Send the setting values of Ethernet settings
R083	FTP server setting request command	Send the setting values of FTP server settings
R099	Command mode request command	Send the setting values of command mode
W000	File saving command	Send ACK after saving the specified file
W102	Setting value individual change command	Send ACK after changing the setting values of the specified item
W103	Setting value batch change command	Send ACK after batch changing the setting values
W111	LD output setting values change command	Send ACK after changing the LD output setting values
W112	LD output automatic adjustment mode change command	Send ACK after changing the LD output automatic adjustment mode
W113	LD external output mode change command	Send ACK after changing the LD external output mode
W114	External trigger mode change command	Send ACK after changing the external trigger mode
W115	Camera internal trigger interval time change command	Send ACK after changing the interval time of the internal trigger mode
W116	Camera exposure time change command	Send ACK after changing the exposure time
W120	Display setting change command	Send ACK after changing the display settings
W121	Zoom setting change command	Send ACK after changing the Zoom settings
W122	Measurement value output setting change command	Send ACK after changing the measurement output settings
W123	GPIO Strobe setting change command	Send ACK after changing the GPIO Strobe settings
W124	Binary threshold for pixel calibration request command	Send ACK after changing the binary threshold used for calibration
W125	Pixel calibration mode change command	Send ACK after changing the calibration mode
W126	Pixel calibration value for user settings change command	Send ACK after changing the pixel calibration value when the calibration mode is user settings
W127	Zero calibration value mode change command	Send ACK after changing the Zero calibration mode
W128	Zero calibration value for user settings change command	Send ACK after changing the zero calibration value for user settings
W129	RAW image output mode change command	Send ACK after changing the RAW image output mode
W081	RS232C setting change command	Send ACK after changing the RS232C settings
W082	Ethernet setting change command	Send ACK after changing the Ethernet settings
W083	FTP sever setting change command	Send ACK after changing the FTP server settings
W099	Command mode change command	Send ACK after changing the command mode
S100	Measurement stop command	Send ACK after measurement is stopped
S101	Measurement start command	Send ACK after measurement is started
S105	LD output automatic adjustment command	Send ACK after automatically adjusting the LD output
S106	Zero reset	Send ACK after zero reset
S107	Zero set	Send ACK after zero set
S108	Offset Tilt judgment 1 change command	Send ACK after changing the judgment area to judgment 1 at Offset Tilt

5 Control from External Devices

Identification character	Command content	Process on the IPU side
S109	Offset Tilt judgment 2 change command	Send ACK after changing the judgment area to judgment 2 at Offset Tilt

Note: The waiting time between each command should be 200msec or more.
The IPU processing may not be in time then processing may not be possible.

■ Command Format

Output formats of each command are explained.
Each character of a format is written with ASCII code.

● In case of normal mode (at factory shipping settings)

A. Readout system

Command formats on readout are explained.

Example: R109 command

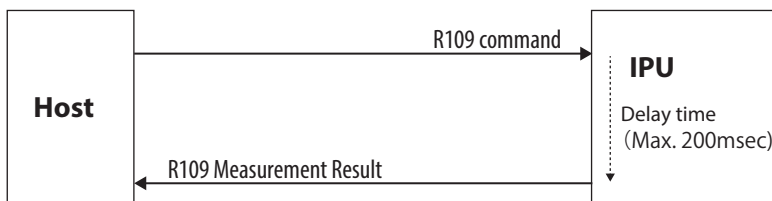

<File readout>

Outputs the setting values to the specified file.

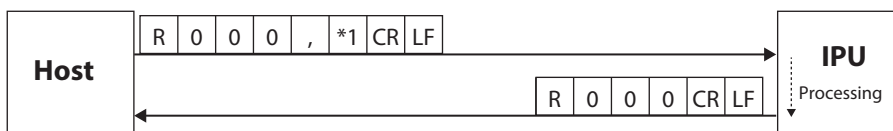

*1: File No. ("0" = Selected file, "1" to "6" = File 1 to 6)

<File basic information readout>

Outputs the basic information of a file.

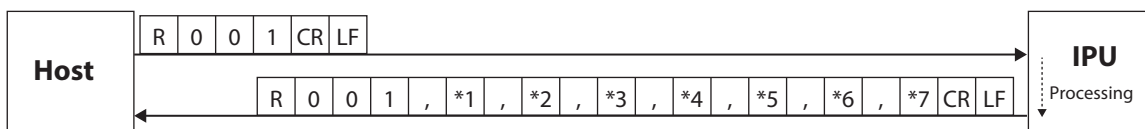

*1: No. of files (1 to 6)

*2: File name 1 (The maximum number of characters = 24)

*3: File name 2 (The maximum number of characters = 24)

*4: File name 3 (The maximum number of characters = 24)

*5: File name 4 (The maximum number of characters = 24)

*6: File name 5 (The maximum number of characters = 24)

*7: File name 6 (The maximum number of characters = 24)

5 Control from External Devices

<Setting value individual readout>

Outputs the present setting value per item.

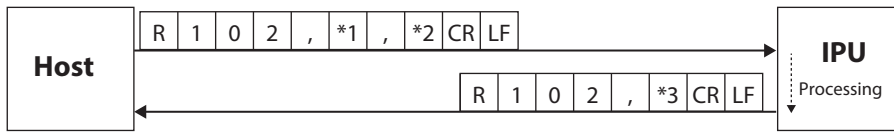

*1: Measurement mode (Here, since it is the angle measurement, “0” becomes the fixed value)

*2: Item code (see the list of item codes shown below)

*3: The setting contents (Value differs depending on items. See <Setting value batch readout>)

List of item codes

Code	Item name
00	Binary level
01	Noise level
02	Effective luminance upper limit value
03	Effective luminance lower limit value
04	Effective luminance judgment mode
05	Judgment type
06	Circle-radius
07	Rectangular-XL
08	Rectangular-XH
09	Rectangular-YH
10	Rectangular-YL
11	Circle2-radius
12	Offset-X
13	Offset-Y
14	Label measurement mode
15	Numbering
16	Judgment label
17	Maximum No. of light spots
18	Center of gravity calculation method
19	Average
20	Effective light spot size mode
21	Effective light spot pixel upper limit value
22	Effective light spot pixel lower limit value

<Setting value batch readout>

Outputs all present setting values.

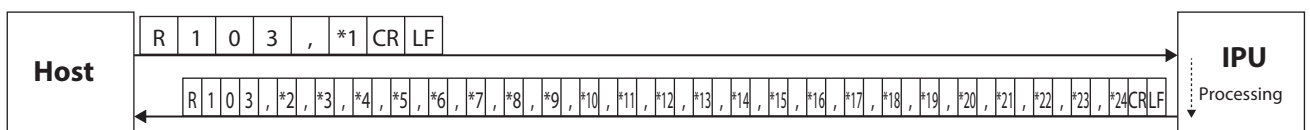

*1: Measurement mode (Here, since it is the angle measurement, “0” becomes the fixed value)

*2: Binary level

1	1	1	1
---	---	---	---

 (600 to 4095)

*3: Noise level

1	1	1	1
---	---	---	---

 (600 to effective luminance lower limit value-1)

*4: Effective luminance upper limit value

1	1	1	1
---	---	---	---

 (Effective luminance lower limit value+1 to 4095)

*5: Effective luminance lower limit value

1	1	1	1
---	---	---	---

 (Noise level+1 to effective luminance upper limit)

value-1)

- *6: Effective luminance judgment mode ("0"= OFF, "1"=ON)
- *7: Judgment type ("0"=OFF, "1"=Circle, "2"=Rectangular)
- *8: Circle-radius (0.001 to 1.750)
- *9: Rectangular-XL (-1.750 to XH-1)
- *10: Rectangular-XH (XL+1 to 1.750)
- *11: Rectangular-YH (YL+1 to 1.750)
- *12: Rectangular-YL (-1.750 to YH-1)
- *13: Circle 2-radius (0.001 to 1.750)
- *14: Offset-X (-1.750 to 1.750)
- *15: Offset-Y (-1.750 to 1.750)
- *16: Label measurement mode ("0"=Single, "1"=Multi Relative, "2"=Multi Absolute, "3"=Offset Tilt D1/D1, "4"=Offset Tilt D1/D2, "5"=Offset Tilt D1/X-Y)
- *17: Numbering ("0"=Area descending order, "1"=Angle ascending order)
- *18: Judgment label ("0"=ALL, "1"=Label1, "2"=Label2, "3"=Label3, "4"=Label4, "5"=Label5)
- *19: Maximum No. of light spots (3 to 5)
- *20: Center of gravity calculation method ("0"=Area center of gravity, "1"=Luminance center of gravity and "2"=Luminance peak)
- *21: Average ("0"=OFF, "1"=2 times, "2"=4 times, "3"=8 times, "4"=16 times)
- *22: Effective light spot size mode ("0" = OFF, "1" = ON)
- *23: Effective light spot pixel upper limit value (Effective light spot pixel lower limit value+1 to 32767)
- *24: Effective light spot pixel lower limit value (1 to Effective light spot pixel upper limit value-1)

<Measurement value readout>

Outputs the present angle measurement value.

The return example is in case of angle measurement (1 spot measurement).

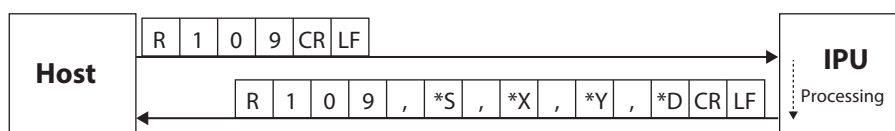

S: Judgment result ("O"=OK, "N"=NG, "E"=ERROR, ""=Judgment OFF)

*X: Angle around the X axis

*Y: Angle around the Y axis

*D: Angle from the measurement center

When setting Target=All, the readout format of easured values in multi setting is added to the end according to the specified maximum number of spots. Please see below.

Single -spot mode: R109,S,X,Y,DCRLF

Multi-spot mode 3spots: R109,S,X1,Y1,D1, ... X3,Y3,D3CRLF

Multi-spot mode 4spots: R109,S,X1,Y1,D1, X4,Y4,D4CRLF

Multi-spot mode 5spots: R109,S,X1,Y1,D1, X5,Y5,D5CRLF

*When Target=1 to 5 is set, the measurement result of the specified Target is output in single setting format.

Info

- The unit of measurement value follows the menu settings.

5 Control from External Devices

The measurement result of the data acquired by the command is in the following format.

[UNIT = deg] (X,Y and D are common)



[UNIT = min + sec] (X,Y and D are common)

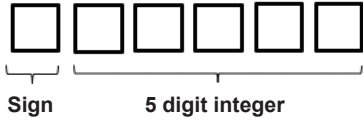

[UNIT = mrad] (X,Y and D are common)

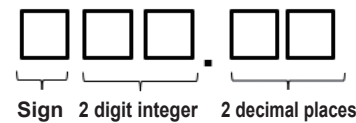

Data acquiring example

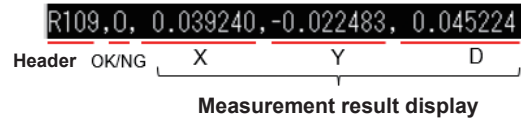

R109,N, 6292, -1369, 6439

R109,0, 71, -85, 110

R109,N,-11910, 556, 11923

The output is converted to seconds

R109,0, 1.04, -0.38, 1.11

R109,N,-32.26, 0.64, 32.26

- * If the measured value has less than the maximum number of digits, the number and sign are right-justified and left blank.
- * When a measurement error occurs, it is filled with commas and 9s as shown below.

[deg] R109,E,999999999,999999999,999999999
 [min + sec] R109,E,999999,999999,999999
 [mrad] R109,E,999999,999999,999999

[Stream, I/O Setting]

"G" is displayed when measurement result reception is not identified by the command header as Stream and IO settings.

Command: R109,0, 71, -85, 110

Stream, I/O: G,0, 217, -23, 218

[Judgment (Tolerance)=On/Off]

When the judgment function is Off, the judgment display area is displayed with "*".
 When the judgment function is On, the judgment display become as OK=[0], NG=[N] or Error=[E] according to the judgment result.

Judgement Off: G*, 217, -23, 218

Judgment On: G0, 217, -23, 218

<LD output setting value readout>

Outputs the LD output setting values.

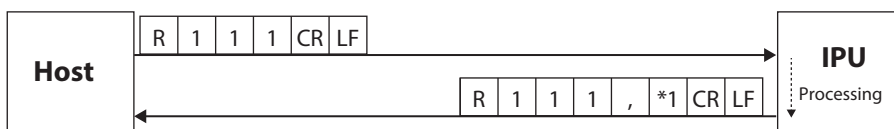

*1: LD output value 1 1 1 1 (0 to 4095)

5 Control from External Devices

<LD output automatic adjustment mode readout>

Outputs the LD output automatic adjustment mode.

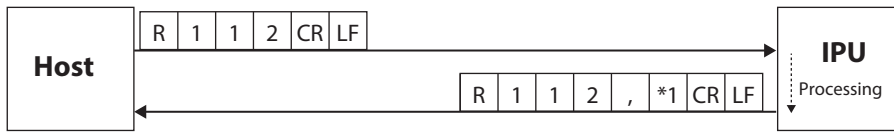

*1: LD output automatic adjustment mode ("0"=OFF, "1"=ON)

<LD external light source mode readout>

Outputs the LD external light source mode.

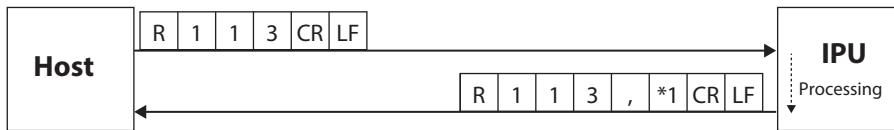

*1: LD external light source mode ("0"=OFF, "1"=ON)

<Camera external trigger mode readout>

Outputs the camera external trigger mode.

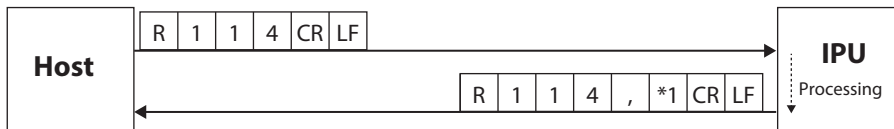

*1: Camera external trigger mode ("0"=OFF, "1"=ON)

<Camera external trigger interval time readout>

Outputs the interval time of camera external trigger.

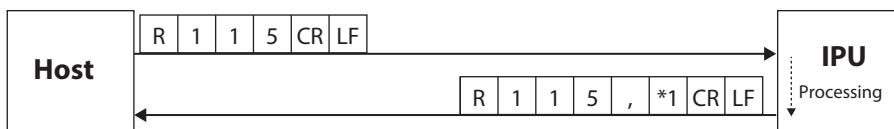

*1: Camera external trigger interval time (25 to 1000)

<Camera exposure time readout>

Outputs the exposure time of the camera.

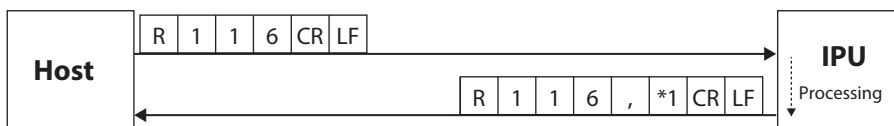

*1: Camera exposure time ("0"=93μs, "1"=200μs, "2"=431μs, "3"=928μs, "4"=2000μs, "5"=4309μs, "6"=9283μs, "7"=20000μs)

5 Control from External Devices

<Measurement luminance value readout>

Outputs the measurement luminance values.

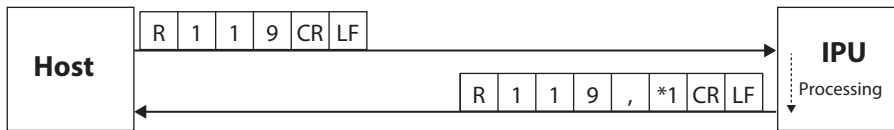

*1: Measurement luminance value (0 to 4095)

<Display setting readout>

Outputs the display settings.

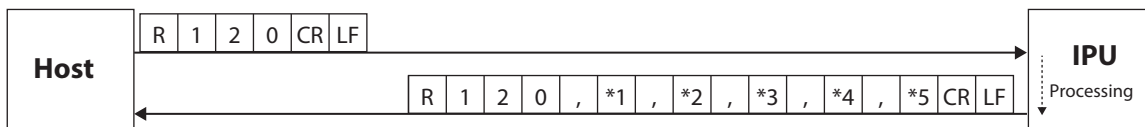

*1: Rotation ("0"=OFF, "1"=Rotate 90° counterclockwise, "2"=Rotate 90° clockwise)

*2: Revert ("0"=OFF, "1"=X On, "2"=Y On, "3"=XY On)

*3: Unit ("0"=deg, "1"=min+sec, "2"=mrad)

*4: Light spot cross display ("0"=OFF, "1"=ON)

*5: Viewing angle ("0"=1.75deg, "1"=1.00deg, "2"=0.50deg, "3"=0.25deg)

<Zoom setting readout>

Outputs the zoom settings.

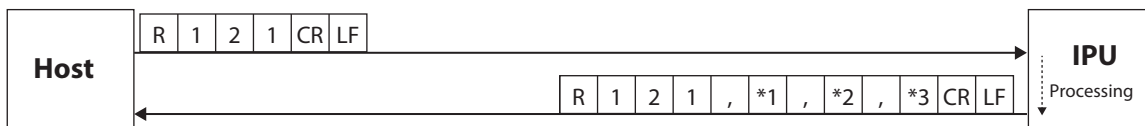

*1: Zoom mode ("0"=OFF, "1"=Fixed value, "2"=Input value)

*2: Fixed value setting ("0"=x2, "1"=x4, "2"=x8)

*3: Input value setting (1.1 to 8)

<Measurement value output setting readout>

Outputs the output setting of measurement values.

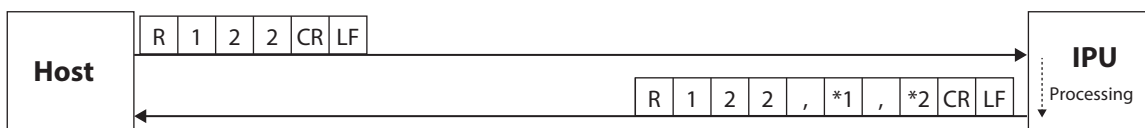

*1: Data output mode ("0"=Stream, "1"=I/O input, "2"=OFF)

*2: Data output port ("0"=Serial, "1"=Ethernet)

5 Control from External Devices

<DIO Strobe setting readout>

Outputs DIO Strobe setting.



*1: Strobe delay time (1 to 999)

*2: Strobe output width (1 to 999)

<Binary threshold for pixel calibration value readout>

Outputs the binary threshold for pixel calibration value.

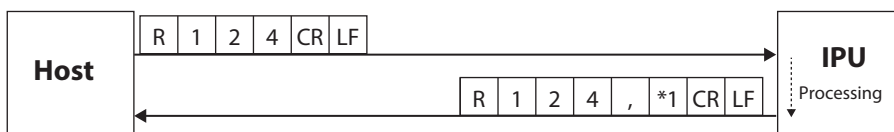

*1: Binary threshold for pixel calibration value (600 to 4095)

<Pixel calibration value readout>

Outputs the pixel calibration value mode.

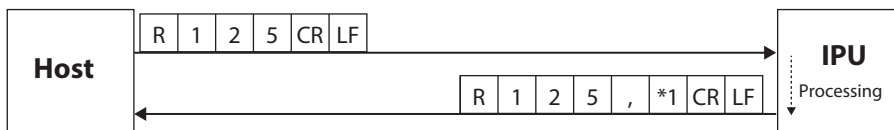

*1: Pixel calibration value mode ("0"=Factory shipping mode, "1"=User setting mode)

<Pixel calibration value for user setting readout>

Outputs the pixel calibration value for user setting mode.

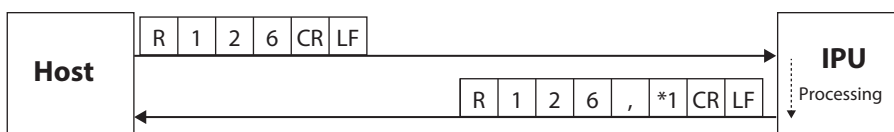

*1: Pixel calibration value (0.001000 to 0.010000)

<Zero point calibration value mode readout>

Outputs the zero point calibration value mode.

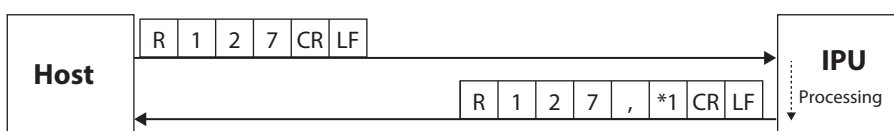

*1: Zero point calibration value mode ("0"=Factory shipping mode, "1"=User setting mode)

5 Control from External Devices

<Zero point calibration value for user setting readout>

Outputs zero point calibration value for user settings.

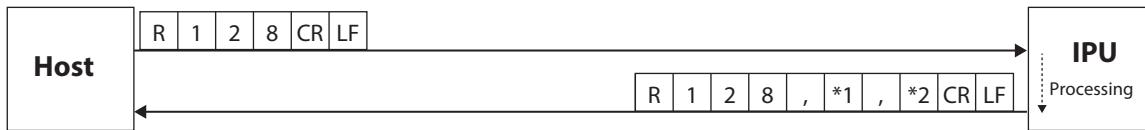

*1: Zero point calibration value X

0	0	0	.	0	0	0
---	---	---	---	---	---	---

 (0 to 960)

*2: Zero point calibration value Y

0	0	0	.	0	0	0
---	---	---	---	---	---	---

 (0 to 960)

<RAW image output mode readout>

Outputs the RAW image output mode.

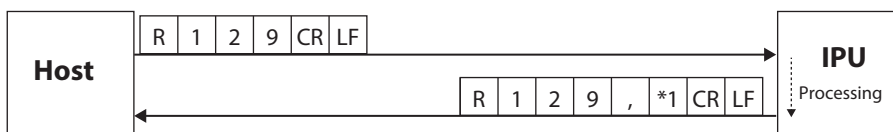

*1: RAW image output mode

1

 ("0"=OFF, "1"=ON)

<LD output automatic adjustment result readout>

Outputs the result of LD output automatic adjustment.

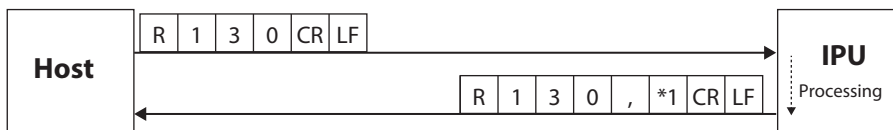

*1: LD output automatic adjustment result

1

 ("0"=OFF or Not adjusted, "1"=Under automatic adjustment, "2"=Successful automatic adjustment, "3"=Failed automatic adjustment)

<System information readout>

Outputs the system information.

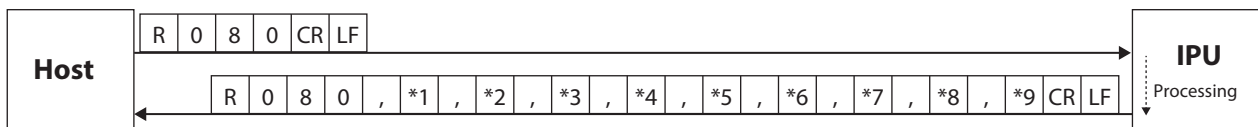

*1: IPU model name

*2: IPU serial number

*3: IPU version

*4: IPU MAC address

*5: IPU manufactured date (yyyymmdd)

*6: Sensor head model name

*7: Sensor head serial number

*8: Sensor head version

*9: Sensor head manufactured date (yyyymmdd)

5 Control from External Devices

<RS232C setting readout>

Outputs the RS232C settings.

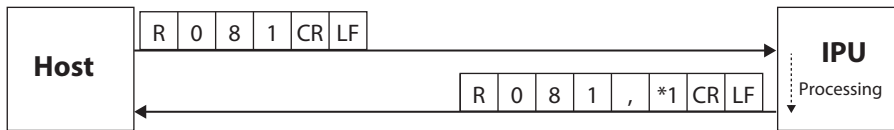

* 1: Baud rate: ("0"=9600, "1"= 19200, "2"= 38400, "3"= 57600, "4"= 115200)

<Ethernet setting readout>

Outputs Ethernet settings.

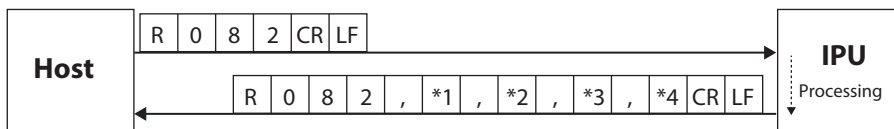

*1: IP address

*2: Subnet mask

*3: Default gateway

*4: Port number for command (1024 to 65534)

<FTP server setting readout>

Outputs the FTP server settings.

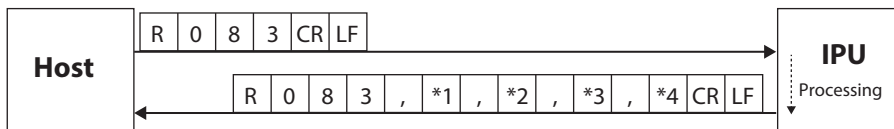

*1: FTP server IP address

*2: FTP server user name (32 characters at maximum)

*3: FTP server password (32 characters at maximum)

*4: FTP server upload path (32 characters at maximum)

<Command mode readout>

Outputs the command mode.

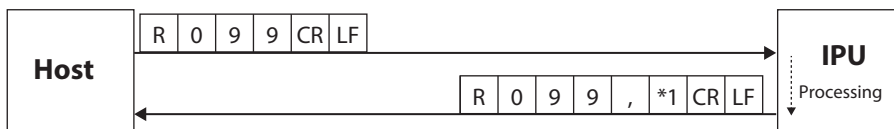

*1: Command mode ("0"=Normal mode, "1"=HIP mode)

5 Control from External Devices

B. Writing type

Command formats on writing such as settings are explained.

Example: W102 command

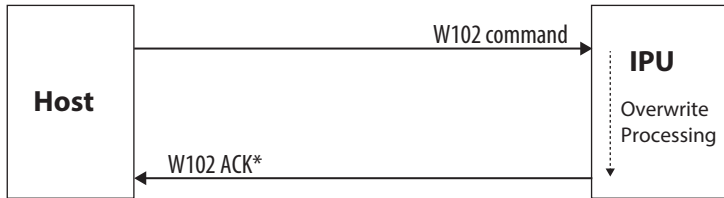

*When a communication error is generated, IPU returns the error command.

<File saving>

Saves the present setting values to the specified file number.

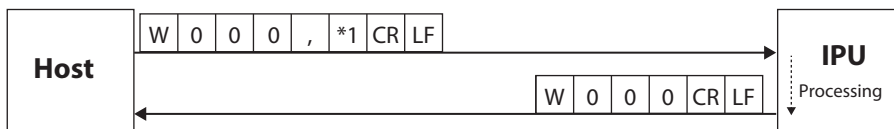

*1: File No. ("0"=Selected file, "1" to "6"=File 1 to 6)

<Setting value individual writing>

Changes the setting values per item.

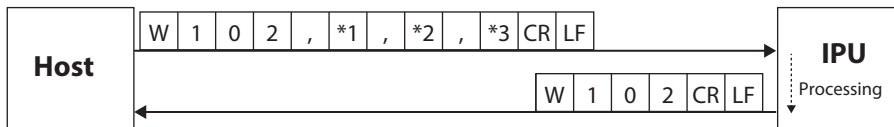

*1: Measurement mode (Here, since it is the angle measurement, "0" becomes the fixed value)

*2: Item code (see the list of item codes shown below)

*3: The setting contents (Value differs depending on items. See <Setting value batch writing>)

List of item codes

Code	Item name
00	Binary level
01	Noise level
02	Effective luminance upper limit value
03	Effective luminance lower limit value
04	Effective luminance judgment mode
05	Judgment type
06	Circle-radius
07	Rectangle-XL
08	Rectangle-XH
09	Rectangle-YH
10	Rectangle-YL
11	Circle2-radius
12	Offset-X
13	Offset-Y
14	Label measurement mode

5 Control from External Devices

Code	Item name
15	Numbering
16	Judgment label
17	Maximum No. of light spots
18	Center of gravity calculation method
19	Average
20	Effective light spot size mode
21	Effective light spot pixel upper limit value
22	Effective light spot pixel lower limit value

<Setting value batch writing>

Changes the setting data in batch.

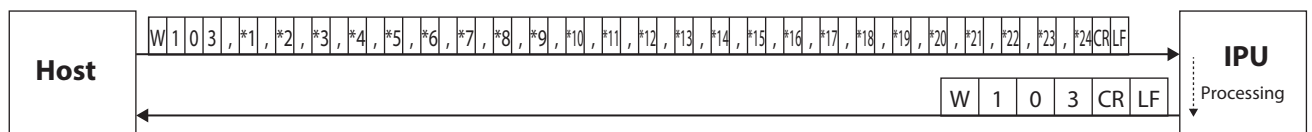

- *1: Measurement mode (Here, since it is the angle measurement, "0" becomes the fixed value)
- *2: Binary level (600 to 4095)
- *3: Noise level (600 to effective luminance lower limit value-1)
- *4: Effective luminance upper limit value (Effective luminance lower limit value+1 to 4095)
- *5: Effective luminance lower limit value (Noise level+1 to effective luminance upper limit value-1)
- *6: Effective luminance judgment mode ("0"=OFF, "1"=ON)
- *7: Judgment type ("0"=OFF, "1"=Circle, "2"=Rectangular)
- *8: Circle-radius (0.001 to 1.750)
- *9: Rectangle-XL (-1.750 to XH-1)
- *10: Rectangular-XH (XL+1 to 1.750)
- *11: Rectangular-YH (YL+1 to 1.750)
- *12: Rectangular-YL (-1.750 to YH-1)
- *13: Circle 2-radius (0.001 to 1.750)
- *14: Offset-X (-1.750 to 1.750)
- *15: Offset-Y (-1.750 to 1.750)
- *16: Label measurement mode ("0"=Single, "1"=Multi Relative, "2"=Multi Absolute, "3"=Offset Tilt D1/D1, "4"=Offset Tilt D1/D2, "5"=Offset Tilt D1/X-Y)
- *17: Numbering ("0"=Area descending order, "1"=Angle ascending order)
- *18: Judgment label ("0"=ALL, "1"=Label1, "2"=Label2, "3"=Label3, "4"=Label4, "5"=Label5)
- *19: Maximum No. of light spots (3 to 5)
- *20: Center of gravity calculation method ("0"=Area center of gravity, "1"=Luminance center of gravity, "2"=Luminance peak)
- *21: Average ("0"=OFF, "1"=2 times, "2"=4 times, "3"=8 times, "4"=16 times)
- *22: Effective light spot size mode ("0"=OFF, "1"=ON)
- *23: Effective light spot pixel upper limit value (Effective light spot pixel lower limit value+1 to 32767)
- *24: Effective light spot pixel lower limit value (1 to Effective light spot pixel upper limit value-1)

5 Control from External Devices

<LD output setting value writing>

Changes the LD output setting values.

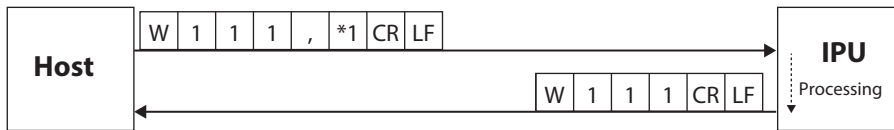

*1: LD output value (9 to 4095)

<LD output automatic adjustment mode writing>

Changes the LD output automatic adjustment mode.

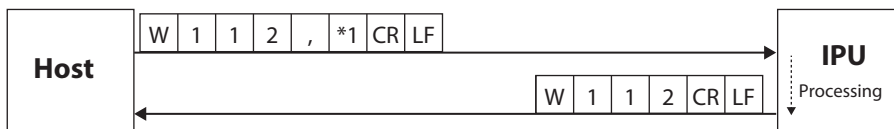

*1: LD output automatic adjustment mode ("0"=OFF, "1"=ON)

<LD external light source mode writing>

Changes the LD external light source mode.

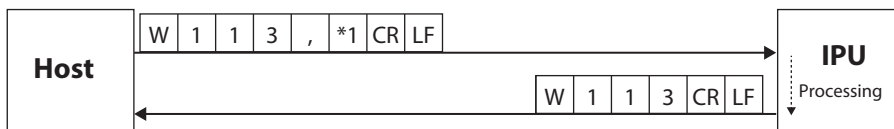

*1: LD external light source mode ("0"=OFF, "1"=ON)

<Camera external trigger mode writing>

Changes the camera external trigger mode.

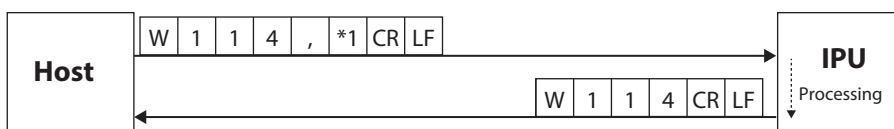

*1: Camera external trigger mode ("0"=OFF, "1"=ON)

<Camera external trigger interval time writing>

Changes the interval time of camera external trigger.

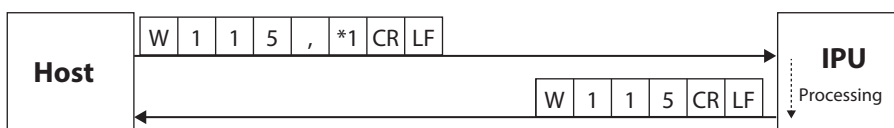

*1: Camera external trigger interval time (25 to 1000)

5 Control from External Devices

<Camera exposure time writing>

Changes the exposure time of the camera.

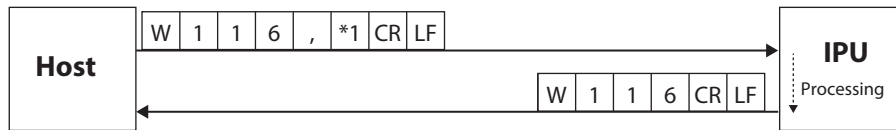

*1: Camera exposure time ("0"=93μs, "1"=200μs, "2"=431μs, "3"=928μs, "4"=2000μs, "5"=4309μs, "6"=9283μs, "7"=20000μs)

<Display setting writing>

Changes the display settings.

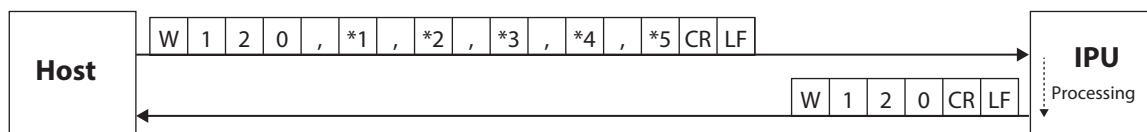

*1: Rotation ("0"=OFF, "1"=Rotate 90° counterclockwise, "2"=Rotate 90° clockwise)

*2: Revert ("0"=OFF, "1"=X On, "2"=Y On, "3"=XY On)

*3: Unit ("0"=deg, "1"=min+sec, "2"=mrad)

*4: Light spot cross display ("0"=OFF, "1"=ON)

*5: Viewing angle ("0"=1.75deg, "1"=1.00deg, "2"=0.50deg, "3"=0.25deg)

<Zoom setting writing>

Changes the zoom settings.

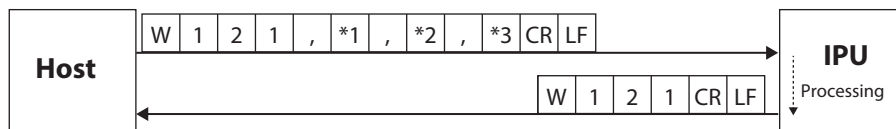

*1: Zoom mode ("0"=OFF, "1"=Fixed value, "2"=Input value)

*2: Fixed value setting ("0"=x2, "1"=x4, "2"=x8)

*3: Input value setting (1.1 to 8)

<Measurement value output setting writing>

Changes the output setting of measurement values.

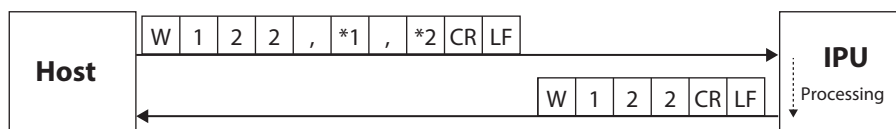

*1: Data output mode ("0"=Stream, "1"=I/O input, "2"=OFF)

*2: Data output port ("0"=Serial, "1"=Ethernet)

5 Control from External Devices

<DIO Strobe setting writing>

Changes DIO Strobe setting.

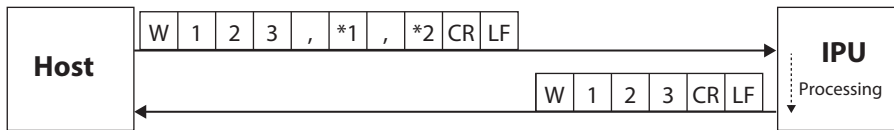

*1: Strobe delay time (1 to 999)

*2: Strobe output width (1 to 999)

<Binary threshold for pixel calibration value writing>

Changes the binary threshold for pixel calibration.

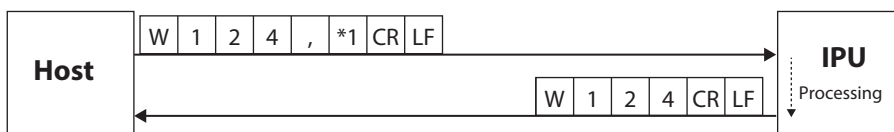

*1: Binary threshold for pixel calibration value (600 to 4095)

<Pixel calibration value mode writing>

Changes the pixel calibration value mode.

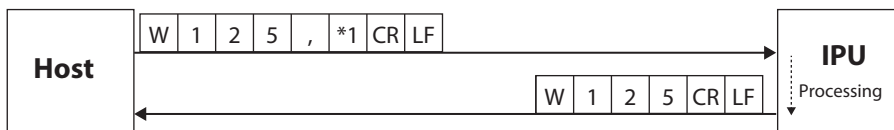

*1: Pixel calibration value mode ("0"=Factory shipping mode, "1"=User setting mode)

<Pixel calibration value for user setting writing>

Changes the pixel calibration value for user setting mode.

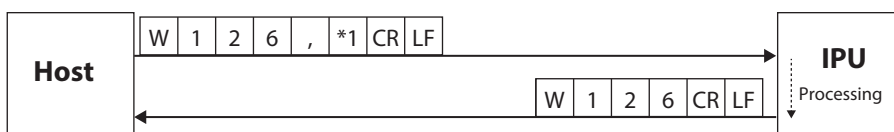

*1: Pixel calibration value (0.001000 to 0.010000)

<Zero point calibration value mode writing>

Changes the zero point calibration value mode.

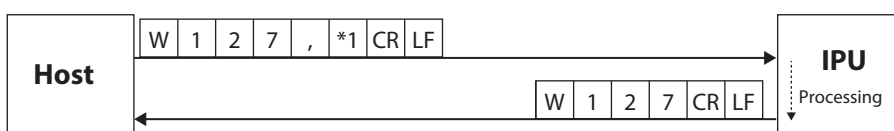

*1: Zero point calibration value mode ("0"=Factory shipping mode, "1"=User setting mode)

5 Control from External Devices

<Zero point calibration value for user setting writing>

Changes the zero point calibration value for user setting mode.

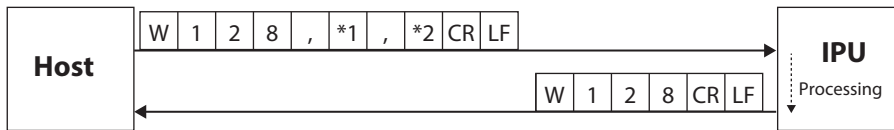

*1: Zero point calibration value X (0 to 960)

*2: Zero point calibration value Y (0 to 960)

<RAW image output mode writing>

Changes the RAW image output mode.

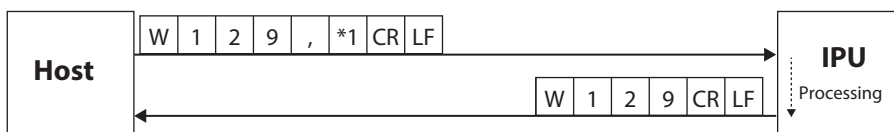

*1: RAW image output mode ("0"=OFF, "1"=ON)

<RS232C setting writing>

Changes the RS232C settings.

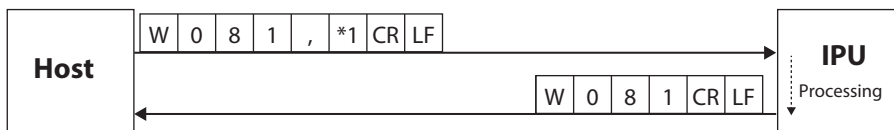

* 1: Baud rate: ("0"=9600, "1"= 19200, "2"= 38400, "3"= 57600, "4"= 115200)

<Ethernet setting writing>

Changes Ethernet settings.

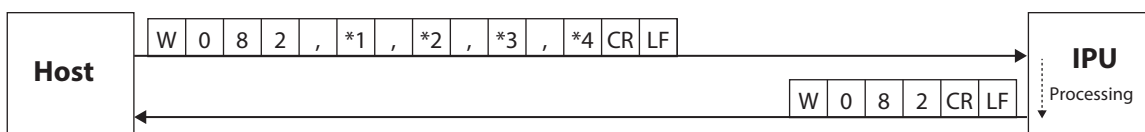

*1: IP address

*2: Subnet mask

*3: Default gateway

*4: Port number for command (1024 to 65534)

<FTP server setting writing>

Changes the FTP server settings.

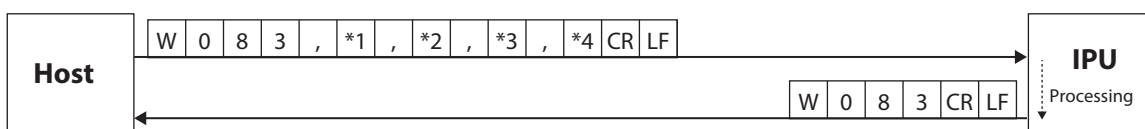

*1: FTP server IP address

*2: FTP server user name (32 characters at maximum)

*3: FTP server password (32 characters at maximum)

*4: FTP server upload path (32 characters at maximum)

5 Control from External Devices

<Command mode writing>

Changes the command mode.

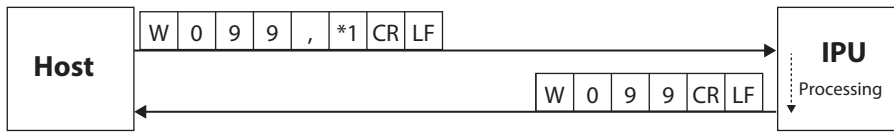

*1: Command mode ("0"=Normal mode, "1"=HIP mode)

C.Execution type

Command formats to execute operations such as measurement start and stop are explained.

Example: S107 command

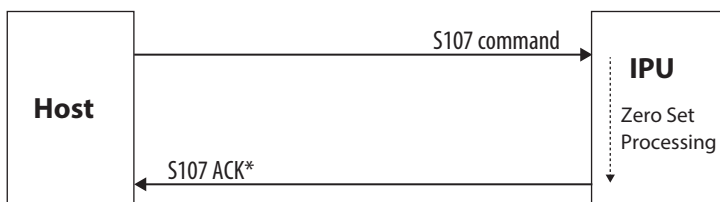

*When a communication error is generated, IPU returns the error command.

<Measurement stop>

Stops a measurement.

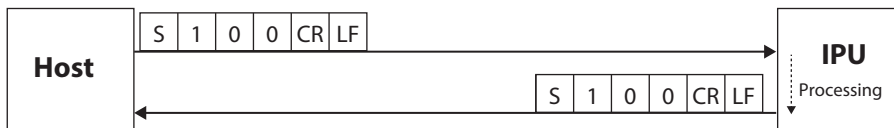

<Measurement start>

Starts a measurement.

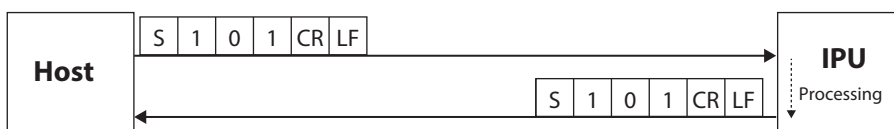

<LD output automatic adjustment>

Adjusts the LD output automatically.

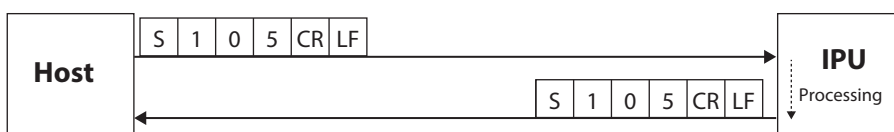

5 Control from External Devices

<Zero reset>

Sets the measurement center in the measurement range center.

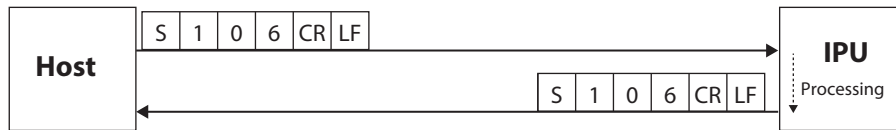

<Zero set>

Sets the measurement center in the light spot on the monitor.

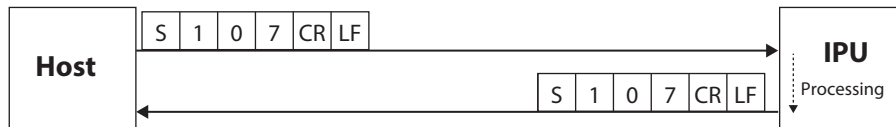

<Switch OFFSETTILT judgment 1>

At OFFSET TILT measurement, switch the judgment area from judgment 2 (D1, D2, X-Y) to judgment 1 (D1).

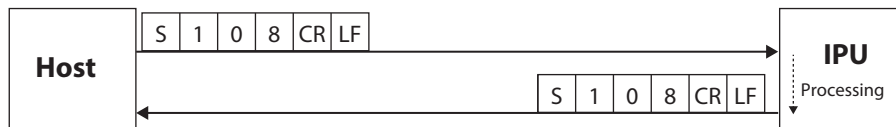

<Switch OFFSETTILT judgment 2>

At OFFSET TILT measurement, switch the judgment area from judgment 1 (D1) to judgment 2 (D1, D2, X-Y).

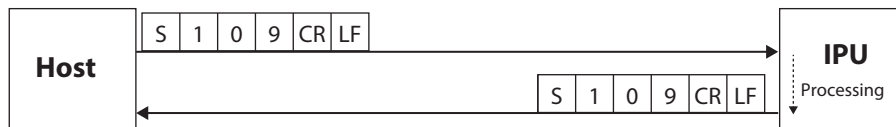

● In case of HIP-1200 mode

A. Readout type

This section explains the format of commands related to reading. For details, please refer to the HIP-1200 instruction manual.

5 Control from External Devices

■ Communication Error

When a command can not be received or executed normally, the error information is sent from this product with the following format.

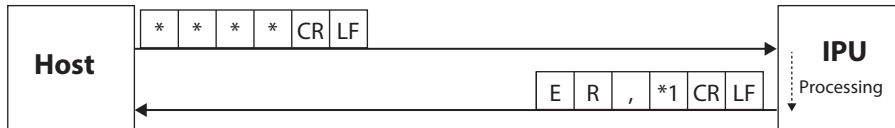

The following error code is entered in *1.

“1”: Communication error

- The number of received characters from the header to [CRLF] is 60 or more.
- After receiving a header, the next character cannot be received for 1 second or more.
- An overrun error or framing error has occurred.

“2”: Setting data error

- Values out of the setting range are set. (It also occurs when the size relationship is incorrect in case of the setting command)

“3”: Command format error

- The number of commas from the header to [CRLF] does not match.
- Setting data are missing or not numeric characters in the setting command.
- Characters after a header contains characters except for those mentioned above.

“4”: Execution error

- At zero set command execution, zero set was not executed since a light spot is not detected.
- When reading a file, data are not saved in the specified file number.

“5”: Condition error

- Could not be executed as it is measuring.
- Prohibited by other settings.

6

Using Input/Output Terminal

In this section, the specification of the input/output terminal and timing chart are explained.

Name of Input/Output Terminal and Function ...	6-2
Timing Chart	6-6

6 Using Input/Output Terminal

Name of Input/Output Terminal and Function

This product is equipped with a 12-Pole connector. In this section, the name of the input/output terminal and function are explained.

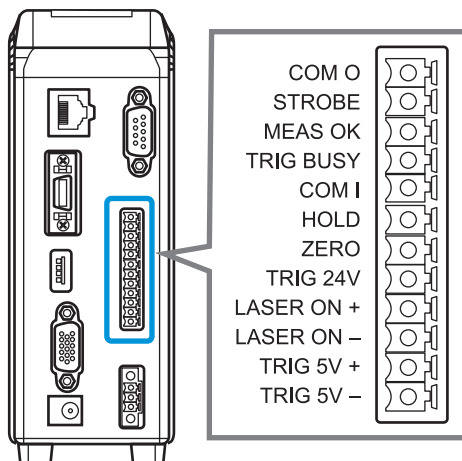

Terminal No.	Terminal Name	Signal	Content
Output 1	COM 0	Output Common	Common terminal for output signal.
Output 2	STROBE	Strobe	Outputs the Strobe signal for judgment result. In case of "H", after judgment, an output is made after passing the time set by the user.
Output 3	MEAS OK	Measurement	Measurement results are output. In case of "H", it is OK, and in case of "L", it is NG.
Output 4	TRIG BUSY	Busy	Outputs the trigger busy. In case of "H", new Start Trigger is ignored. Info "H" continues from starting of Start Trigger to the image capture complete.
Input 1	COM1	Input Common	Common terminal for input signal.
Input 2	HOLD	Hold	Measurement results are held. At the Internal Trigger Mode, when the result hold input is "H", the process continues; however, the measurement results output (RS232C and Ethernet) functions as follows. In IO mode: Result immediately before is output once. In Stream mode: No output is made. Info The result hold is not used in the External Trigger Mode.
Input 3	ZERO	Zero Set	It is used for setting/resetting of the measurement origin point. In case of the Offset Tilt measurement, judgment standard is switched.
Input 4	TRIG 24V	Measure Trigger 24V	When the measurement start trigger is "H", a measurement starts. Info It is valid only when the trigger mode is set to External.
Input 5	LASER ON +	Laser (+)	By short circuiting +/- terminal, laser emission can be done.
Input 6	LASER ON -	Laser (-)	
Input 7	TRIG 5V +	Measure Trigger 5V (+)	When the measurement start trigger is "H", a measurement starts.
Input 8	TRIG 5V -	Measure Trigger 5V (-)	Info It is valid only when the trigger mode is set to External.

"H"=Contact point ON, "L"=Contact point OFF.

Equivalent Circuit Scheme

The circuit diagram of input/output terminals and connection examples are explained.

IO Output

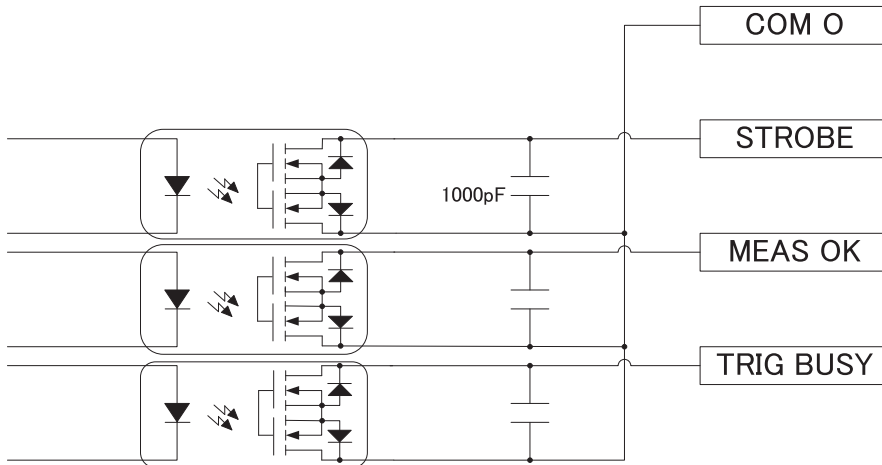

IO Input

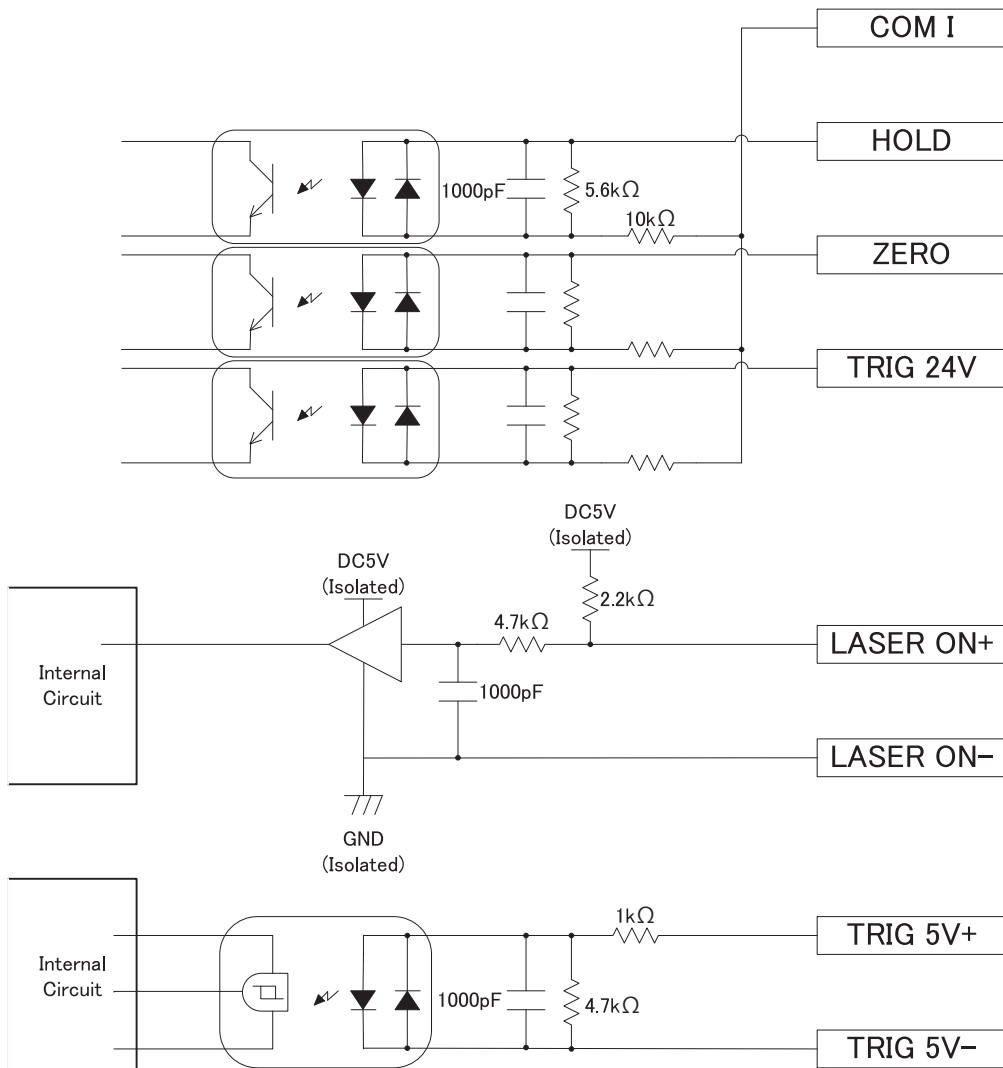

6 Using Input/Output Terminal

● IO Input connection example (Connection from NPN output)

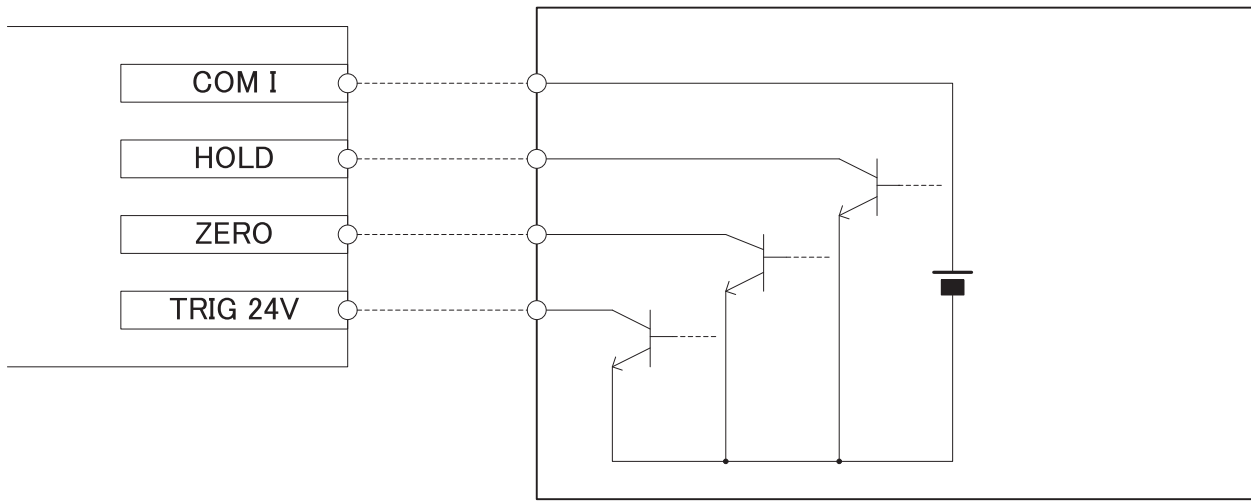

● IO Input connection example (Connection from PNP output)

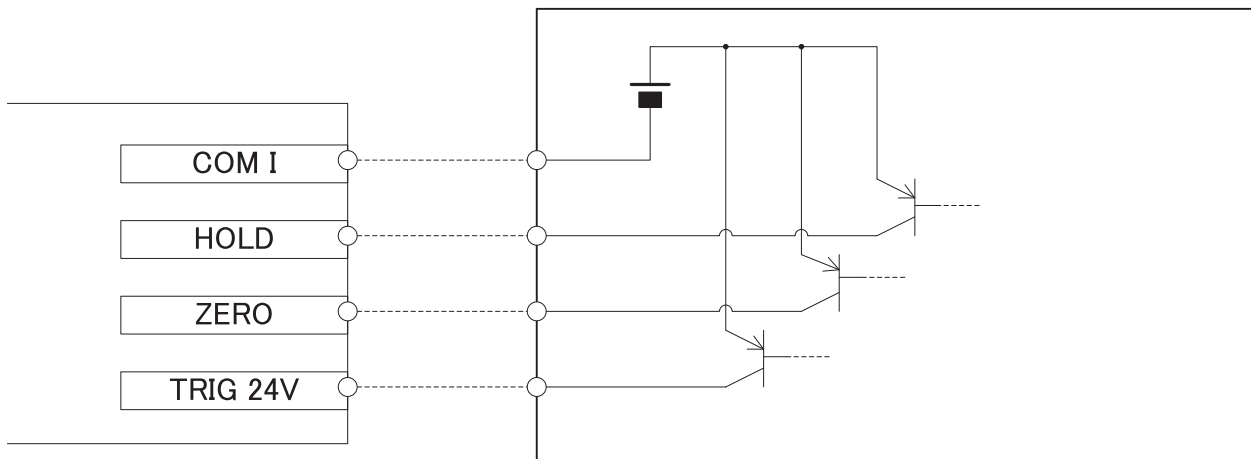

● IO Output connection example (Connection to NPN input)

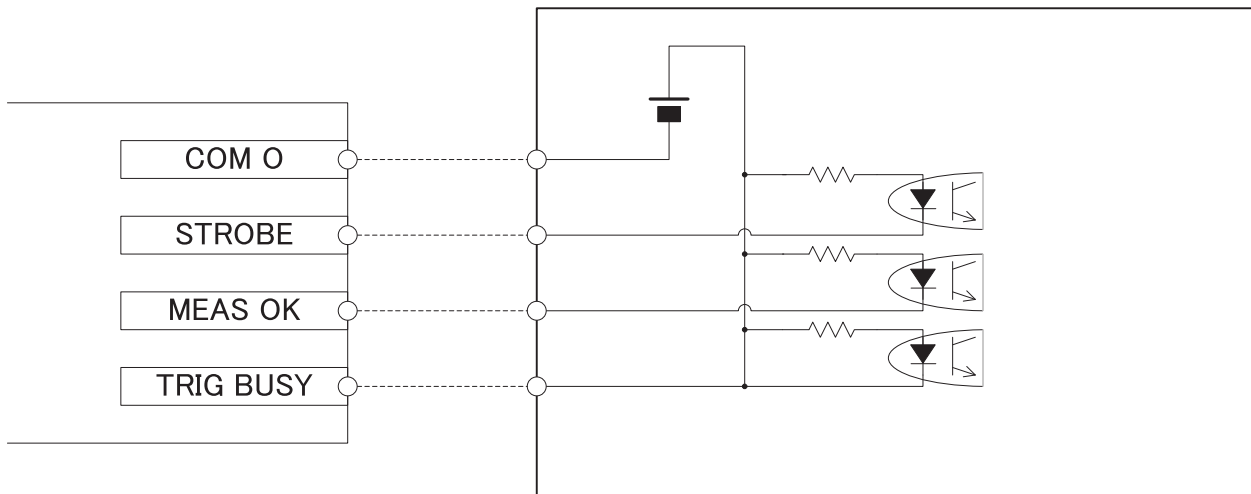

6 Using Input/Output Terminal

● IO Output connection example (Connection to PNP input)

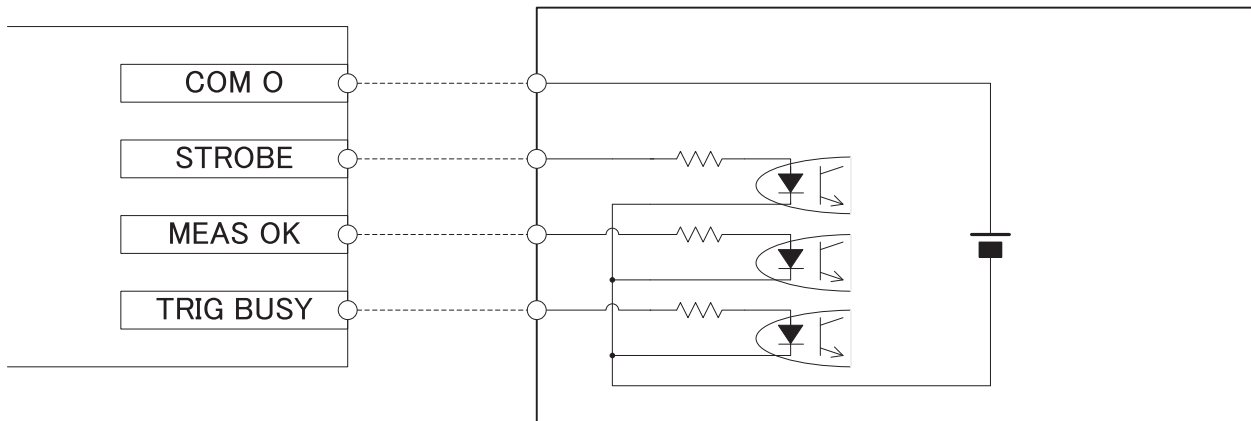

● LASER ON +/- Connection Example

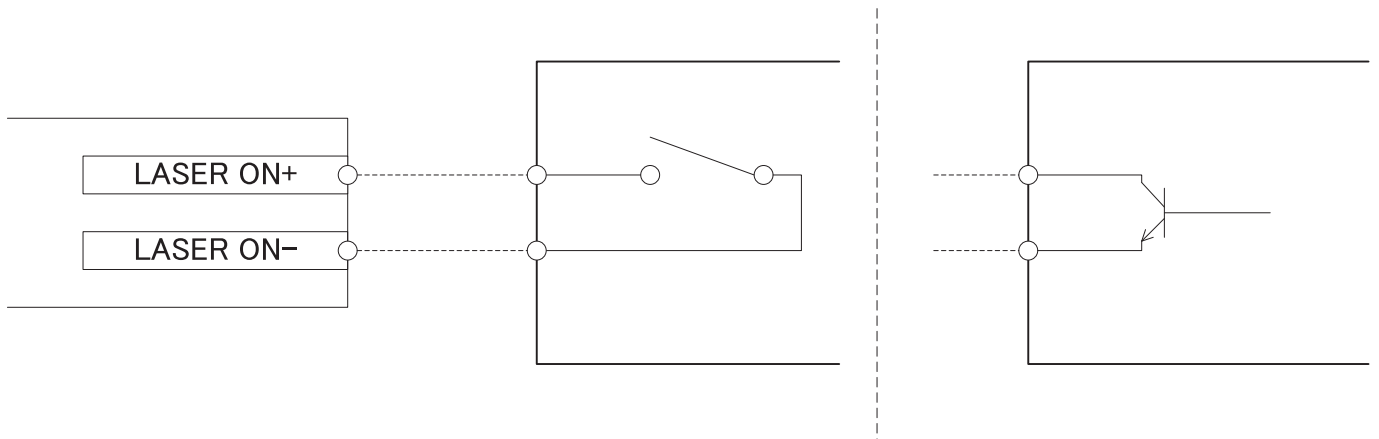

● TRIG 5V +/- Connection Example

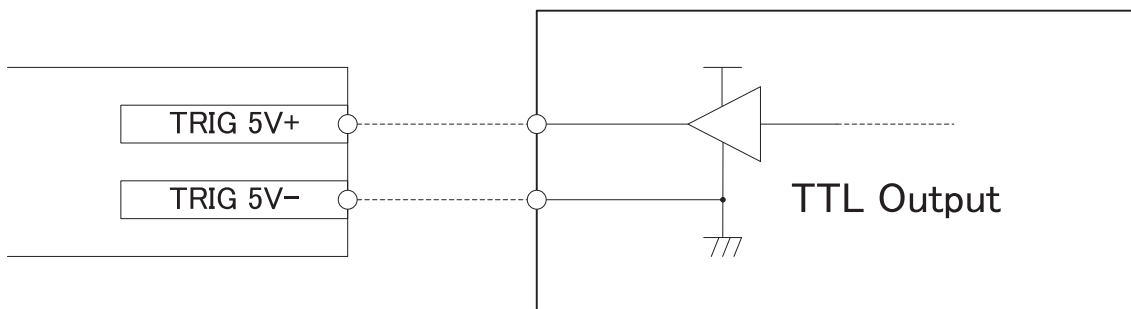

6 Using Input/Output Terminal

Timing Chart

In this section, the timing of input/output signal is explained.

Internal Trigger Mode

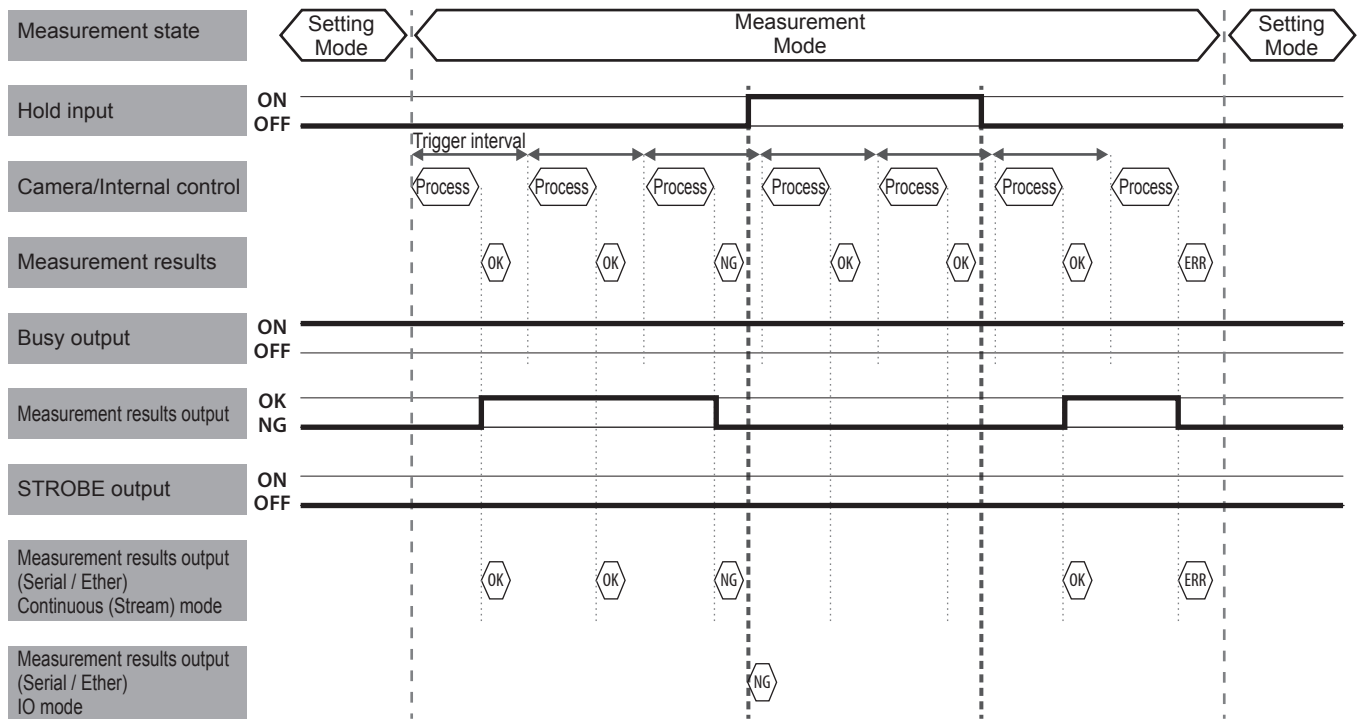

External Trigger Mode

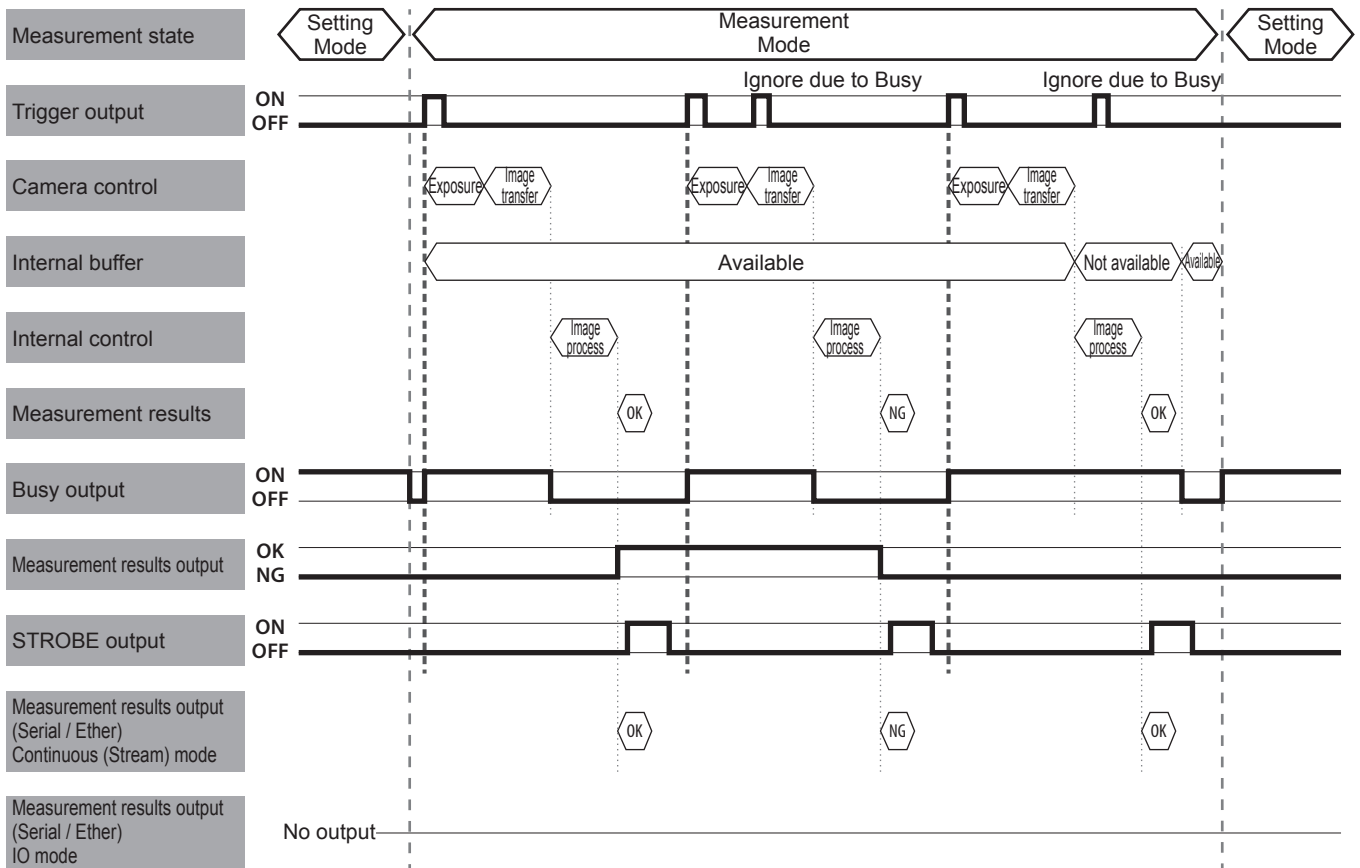

6 Using Input/Output Terminal

■ Details of Strobe Signal

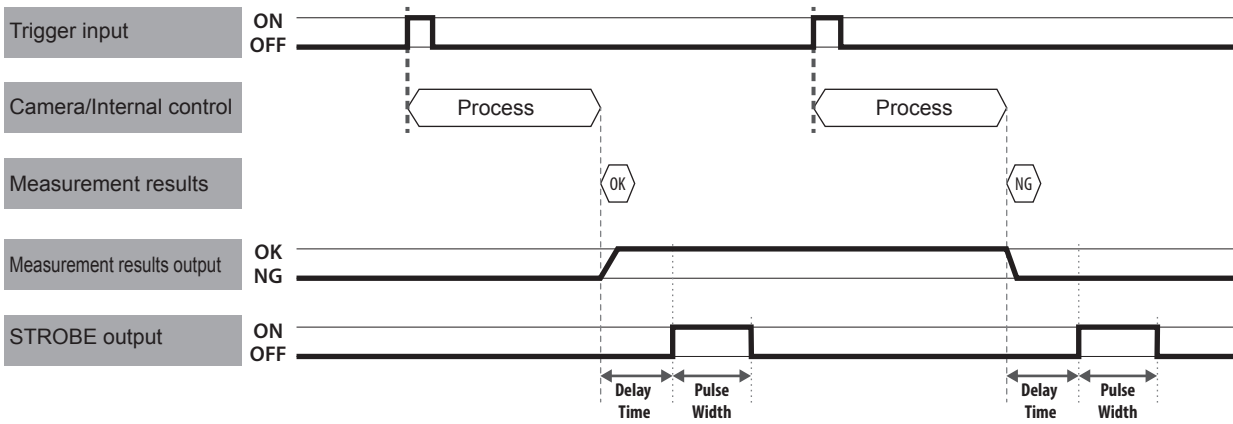

■ Details of Zero Set Signal

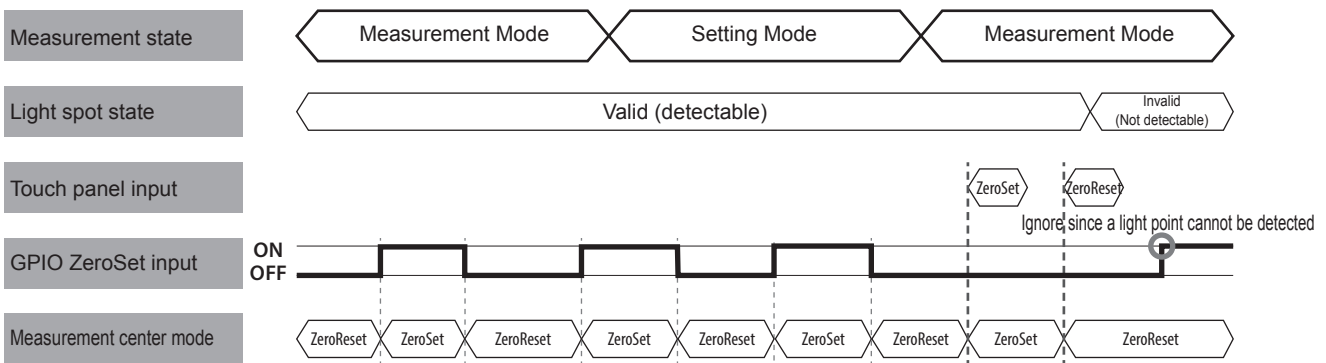

7

Specification

In this section, specifications of IPU and head, and external dimensions figure are explained.

Main Specifications	7-2
External Dimensions	7-5

7 Specification

Main Specifications

NOTE

Please note that a part of specifications in this product may be changed without prior notice to improve performance.

■ IPU

Item		Specification
Model No.		HPU-500,HPU-1000
Connection sensor head		H410-175R, H410-175S1, H410-175G1, H410-175B1, H410-175G1-30
No. of sensor head connections		1
Rating	Power source voltage	DC 24 V \pm 10% *Power source ripple 10% or less (<12 Vp-p)
	Input current	1.8 A or less
	Output	Sensor head power source supply: 12 V, 0.5 A Touch panel monitor power source supply: 12 V, 0.5 A
12-core connector (DIGITAL I/O)	Output circuit (Output 2, Output 3, Output 4)	NPN/PNP common open drain output Withstand voltage: 30 V or less Driving maximum current: 50 mA or less Residual voltage: 0.5 V or less Leaking current at OFF output: 0.1 mA or less
	Input circuit (Input 2, Input 3, Input 4)	NPN/PNP common voltage input Input maximum voltage: 30 V Input current: 2.3 mA On voltage: 15 V or more OFF voltage: 2 V or less
	Input circuit (Input 5 (+), Input 6 (-))	Laser on input (no voltage contact, laser output with short circuit of +/-) Internal voltage: 5 V Short circuit current: 2 mA OFF (open) input condition: 10 K Ω or more or 4 V or more ON (short) input condition: 0.5 K Ω or less or 1 V or less
	Input circuit (Input 7 (+), Input 8 (-))	Measurement start trigger input (measure with 5 V system signal and starting edge detection) Input voltage: 0 to 6 V Input current: 4 mA (5 V input) On voltage: 3.5 V or more OFF voltage: 1 V or less
	Function	Output 1: Common for output signal Output 2: Judgment result strobe output Output 3: Judgment results output Output 4: Trigger busy output Input 1: Common for input signal Input 2: Result hold input Input 3: Zero set input Input 4: Measurement start trigger input (24 V system signal) Input 5 (+) / Input 6 (-): Laser on input (no voltage contact point) Input 7 (+) / Input 8 (-): Measurement start trigger input (5 V system signal)
Monitor output	Output specification	Analog RGB output
	Resolution	1024 \times 768 pixels
	Connector	High density D-sub 15-pin

7 Specification

Item		Specification
Operation input	USB	USB 2.0 Type-A connector Operation input from the touch panel monitor and mouse
External communication	RS232C	D-sub 9-pin connector (use the cross cable) Baud rate: 9600, 19200, 38400, 57800, and 115200 Measurement data output and control command input/output
	Ethernet	RJ-45 connector Transmission method: 1000Base-T and 100Base-TX Communication method: TCP/IP, FTP and socket communication Measurement data output and control command input/output
Display		LED (Green/Red)
Environment condition	Ambient temperature for use	0 to 40°C
	Ambient humidity for use	35 to 85% RH
	Storing temperature	-10 to +60°C
	Vibration resistance	Frequency range: 10 to 500 Hz Maximum acceleration: 2 G and X/Y/Z axis
Weight		Approx. 900 g

■ Sensor Head

Item		Specification				
Model No.		H410-175R	H410-175S1	H410-175RG1	H410-175B1	H410-175G1-30
Light source	Wave length	655 nm±10nm	852 nm±10nm	520nm±10nm	450nm ±10nm	520nm ± 10nm
	Output	< 0.39 mW Laser Class 1	< 0.78 mW Laser Class 1	< 0.39 mW Laser Class 1	< 0.39 mW Laser Class 1	< 1.0mW Laser Class 2
	Emission position	20±0.5 mm or less (Distance from the reference surface 1) 15±0.5 mm or less (Distance from the reference surface 2)				
	Emission angle	±0.05 degrees or less				
Angle measurement range		1.75 degrees: Measurement distance < 120 mm 1.00 degrees: Measurement distance < 200 mm 0.50 degrees: Measurement distance < 300 mm				
Spot diameter		Approx. φ1.0 mm				Approx. φ3.0 mm
Resolution		1 second *System resolution (Total Angular calculated resolution including image processing unit)				
Repeatability		3.6sec (Guaranteed) 1sec (Average)				3.6sec (Guaranteed)
Linearity		±2% of F.S. (Guaranteed) ±0.2% of F.S. (Average)	±2% of F.S. (Guaranteed) ±0.4% of F.S. (Average)			±2% of F.S. (Guaranteed)
Measurement sampling cycle		25 msec or more				

7 Specification

Item		Specification	
Display		LED (Green/Red)	
	Ambient temperature for use	0 to 40°C	
	Ambient humidity for use	35 to 85% RH	
	Performance guarantee temperature	23 ± 5°C	
	Storing temperature	-10 to +60°C	
	Vibration resistance	Frequency range: 10 to 500 Hz Maximum acceleration: 2 G and X/Y/Z axis	
Weight		Approx. 160 g	

■ AC Adaptor (Optional)

Item	Specifications
Model	HDC24V-2710MA
Rating Input	Single Phase ,100 to 240 Vac, 50 to 60 Hz, 1.4A Max.
Rating Output	DC 24V ± 5% 2.71A Max.
Input connector	IEC60320 C14 type *Include AC power cable (Type A plug, Length = 1 m)
Output connector	DC Power supply connector for HPU-1000 Plug Type: MC 1.5/3-STF3.5 BK DC cable length: 1.6 m
Dimensions	115 mm x 53 mm x 38 mm (W x H x D)
Weight	510 g

■ Sensor Head Cable

Model	Length	Weight
HSHC1-1.5	Approx. 1.5 m	120 g
HSHC1-4	Approx. 4 m	250 g
HSHC1-10	Approx. 10 m	600 g

■ Robot Cable

Model	Length
HSHC1-4-R	Approx. 4 m
HSHC1-6-R	Approx. 6 m

External Dimensions

■ IPU HPU-500, HPU-1000

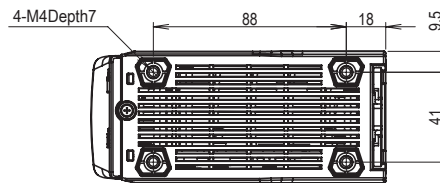
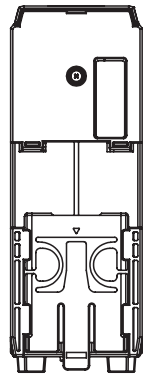
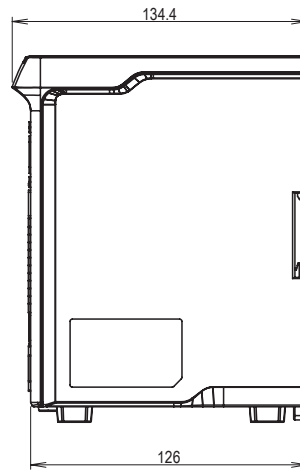
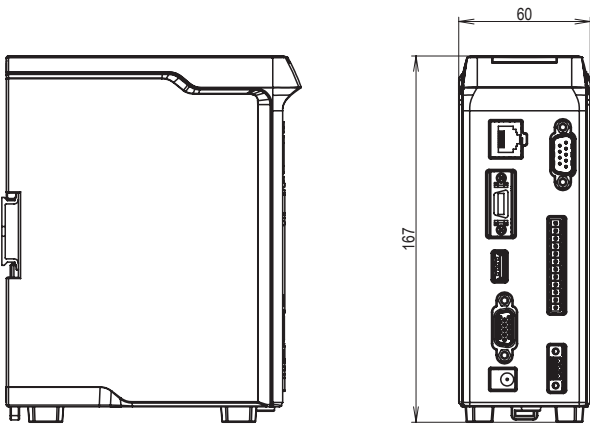
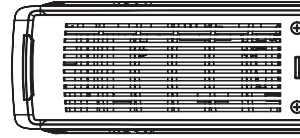

7 Specification

■ Sensor Head H410 Series

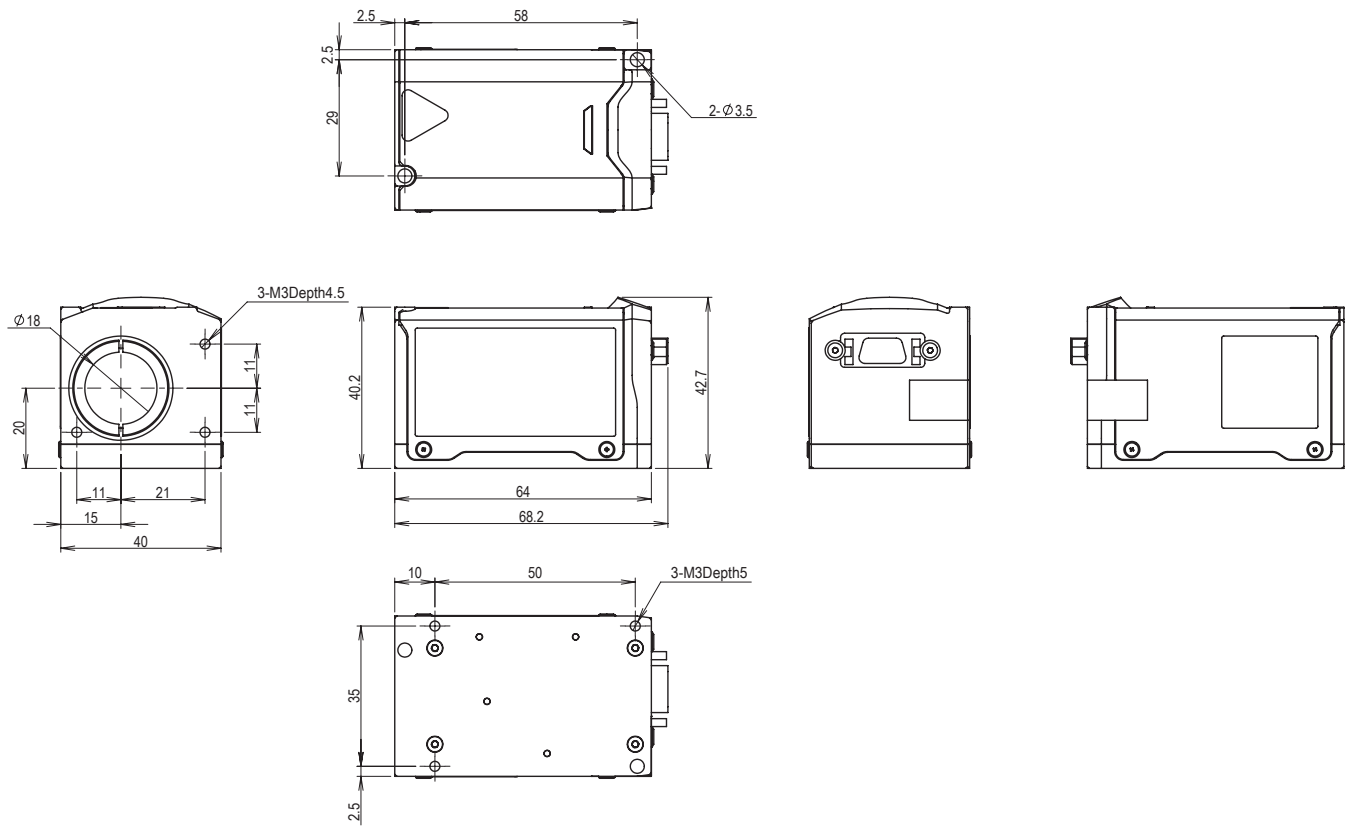

8

Troubleshooting

When errors and trouble are generated on the operation of this product, please read this section.

LED display state.....	8-2
Error messages	8-2
Phenomena and measures	8-3

8 Troubleshooting

LED display state

The state of this product can be checked with the LED.

When errors and trouble are observed, always check the LED display first.

Display state (IPU/Head)	Meaning	Measures
Red ON	Disconnected communication with the sensor Head	Check if the sensor head is connected properly.
Red ON	EE-PROM failure	When the symptom remains even after turning the power OFF and ON, it is possible that there is a failure. Please contact our sales agency.
Red ON	Damaged saved data	Since the saved setting data are damaged, create and save the setting data again.

Error messages

Depending on the state of this product, an error message may be displayed on the touch panel monitor.

Examples of display contents are explained below.

Display state	Meaning	Measures
System Error 381: EEPROM read error.	EEPROM readout error (At power source launching)	Restart this product. When the symptom remains even after turning the power OFF and ON, it is possible that there is a failure. Please contact our sales agency.
System Error 624: EEPROM write error.	EEPROM writing error (At saving the setting)	Restart this product. When the symptom remains even after turning the power OFF and ON, it is possible that there is a failure. Please contact our sales agency.
System Error 831: Serial Number and Product Data not found.	MAC Address / Serial Number unwritable error.	Restart this product. When the symptom remains even after turning the power OFF and ON, it is possible that there is a failure. Please contact our sales agency.
System Error 100: Failed to load from EEPROM. System Settings have been initialized.	EEPROM readout data error (At system setting readout)	The system settings are damaged. Restart this product. When the symptom remains even after turning the power OFF and ON, it is possible that there is a failure. Please contact our sales agency.
System Error 10* Failed to load from EEPROM. Setting * has been initialized. (*= 1 to 6)	EEPROM readout data error (At readout of each setting file)	Since the saved setting data are damaged, create and save the setting data again.
The sensor head has been disconnected. Please reboot.	Sensor head not connected error	Turn the power source OFF, and connect the sensor head. Turn the power source ON again.
Failed to connect to the FTP server.	FTP server connection error	<ul style="list-style-type: none"> • Check the FTP settings. • Check the connection of the Ethernet cable.

Display state	Meaning	Measures
[deg] R109,E, 999999999,999999999, 999999999 [min+sec] R109,E, 999999,999999, 9999999 [mrad] R109,E,999999, 999999,9999999 Or Only "Error" on Monitor	Unable to determine error due to possible multiple errors	Error due to object angle calculation, or error due to sensor head or image processing unit. Please try to measure the object angle using a standard mirror (equivalent to our model: HS-0). If the angle can be measured, the error is due to the angle calculation software. Please contact us for countermeasure software. If not, the device may not work properly. Please contact us for repair. NOTE Regardless of external light source or internal light source, if the shape of the reflection or light source is elongated elliptical or linear, it may not be possible to measure.

Phenomena and measures

Information that is helpful for troubleshooting is described below.
Check if the generated trouble is found in the list below.

Phenomenon	Cause	Measures
The power does not turn ON.	The AC adapter and power source code are not connected correctly.	Connect the AC adapter and power source code correctly.
	DC24V is not supplied.	Connect to DC24V power source correctly.
Nothing appears on the monitor.	Not connected to the power source correctly.	Connect the monitor power source connection cable correctly.
	The monitor cable is not connected correctly.	Connects the monitor cable (VGA cable D-sub 15-pin) correctly.
	The monitor's power source is OFF.	Turn the power source button on the back of the monitor ON.
The touch panel does not work.	The touch panel cable is not connected correctly.	Connect the touch panel connection cable (USB cable) correctly.
No light spot is displayed on the monitor / the light reception amount is not stable.	Input 5 (LASER ON (+)) of the 12-core connector and input 6 (LASER ON (-)) are not short circuited.	Short circuit Input 5 (LASER ON (+)) of the 12-core connector and input 6 (LASER ON (-)) with a short pin.
	The shutter speed is too fast / too slow.	Adjust the shutter speed to adequate speed.
	The tilt of measurement target object is large.	Adjust the tilt of measurement target object so that the reflection light enters within the visual angle $\pm 1.75^\circ$. *When setting the Zoom, it is the incident of visual angle according to the magnification.
	The reflection rate of the measurement target object is low.	Adjust the LD power or shutter speed to make the light reception amount adequate.
	The LD Power setting is low.	Adjust so that the LD power setting value is adequate.
	The setting of [Light Source] is [External].	When external light source is not used, set the setting of [Light Source] to [Internal].

8 Troubleshooting

Phenomenon	Cause	Measures
No light spot is displayed on the monitor / the light reception amount is not stable.	Zoom magnification is large.	Adjust the Zoom magnification or viewing angle so that the tilt of the measurement target object is within the range of visual field. *The maximum value of visual angle is $\pm 1.75^\circ$.
	The effective range of [Valid Light Spot Pointer] is narrow.	Set the effective range sufficient for the actual light spot size.
	End of lifespan of the laser.	Please contact our sales agency.
Measurement results show error.	There are more pixels than the specified number which luminance value is saturated.	Adjust the LD power or shutter speed to make the luminance value adequate. *The specified number of saturated pixels differ depending on [Detect Mode].
	The luminance value is out of the range of the effective light spot judgment threshold.	Set so that the effective judgment threshold is adequate. *The effective light spot judgment threshold differs depending on [Detect Mode].
Unable to communicate with RS232C.	The RS232C cable is not connected correctly.	Connect the RS232C cable (D-sub 9-pin) correctly.
	An adequate cable is not used.	Use an RS232C cross cable.
	Communication conditions on the PC are not set correctly.	Set the communication conditions on the PC correctly.
Unable to communicate with Ethernet.	The Ethernet cable is not connected correctly.	Connect the Ethernet cable correctly.
	An adequate communication cable is not used.	Use an adequate Ethernet cable. This product supports 1000base-T and 100base-TX.
	Communication conditions on the PC are not set correctly.	Set the communication conditions on the PC correctly.
Error is returned in command.	The screen is in the operation mode.	In the operation screen, a part of commands that influence measurement cannot be received. Move to the setting screen and send the command.
Trigger input is not accepted.	A connection to the input 4 (TRIG 24 V) of the 12-core connector or input 7 (TRIG 5V (+))/input8 (TRIG 5 V (-)) wiring is not correct.	Connect to the input 4 (TRIG 24 V) of the 12-core connector or input 7 (TRIG 5V (+))/input 8 (TRIG 5 V (-)) wiring correctly.
	The setting of [Trigger Mode] is [Internal].	Change [Trigger Mode] to [External].
	The screen is in the setting mode.	Switch to the operation screen.
The image does not get updated.	The setting of [Trigger Mode] is [External].	Perform trigger input or change [Trigger Mode] to [Internal].

Warranty

● Warranty Period and Range

When contacting our service office, please let us know the serial number of this product.

The warranty period is one year after delivery.

However, it becomes out of warranty range for the following cases, and a fee is required for a repair.

- Damage and failure caused by incorrect use, modification and repair carried out by those who are not our company's personnel.
- When the modification prevention seal is broken.
- Damage and failure caused by a drop at transferring and moving, and inappropriate handling.
- Damage and failure caused by fires, salt damage, harmful gases, abnormal voltage, and earthquake, and other natural disasters such as lightning, wind and water disaster.
- Damage and failure generated by handling against the explanations and cautions mentioned in this manual.

● After Sales Service

Before contacting our service office, check the items listed in Page 8-2: "Error messages".

If you have questions, please contact the optical system division, sales section of our company.

<<During Warranty Period>>

When damage occurs under a normal use state following the cautions/warnings/notes written in this manual, a repair is done for free.

For any damages out of warranty period mentioned above, a fee is required for a repair.

<<Warranty Period has Passed>>

When functions can be maintained with repairs, a repair is conducted with a fee if requested.

● Repairable period

The minimum possessing period of performance parts used for repairs of this product (necessary parts required to maintain functions) shall be one year from the end of manufacturing of this product. This period is the repairable period. A repair may be possible even after passing the possessing period of parts, please contact the optical system division, sales section of our company.

*Regarding the damage generated in this product, our company shall not be held responsible except for the repair based on this warranty.

SURUGA SEIKI CO.,LTD.

Overseas Sales

Tel: +81-3-6403-4513

Fax: +81-3-6403-4514

<https://eng.surugaseiki.com/>